

# STANDARD MEASUREMENT SYSTEM



## INTERPRETATIONS

## TABLE OF CONTENTS

<b>69.101 PURPOSE</b> .....	<b>4</b>
<b>69.103 DEFINITIONS</b> .....	<b>4</b>
<b>69.105 APPLICATION FOR MEASUREMENT SERVICES</b> .....	<b>8</b>
<b>69.107 GROSS AND NET TONNAGES</b> .....	<b>8</b>
(a) GROSS TONNAGE.....	8
(b) NET TONNAGE .....	8
<b>69.109 UNDER-DECK TONNAGE</b> .....	<b>9</b>
(a) DEFINED.....	9
(b) METHOD OF CALCULATING TONNAGE .....	9
(c) IDENTIFYING THE TONNAGE DECK.....	9
(d) ENUMERATING THE DECKS TO IDENTIFY THE SECOND DECK FROM THE KEEL.....	9
(e) IDENTIFYING THE LINE OF THE TONNAGE DECK.....	10
(f) TONNAGE LENGTH.....	10
(g) DIVISION OF VESSEL INTO TRANSVERSE SECTIONS.....	14
(h) DEPTHS OF TRANSVERSE SECTIONS ( <i>see also §69.109(p) and (q)</i> ).....	15
(i) BREADTHS OF TRANSVERSE SECTIONS ( <i>see also §69.109(p) and (q)</i> ).....	16
(j) MEASURING SPACES HAVING CEILING .....	18
(k) AREA OF TRANSVERSE SECTIONS .....	18
(l) <i>CALCULATING TONNAGE FROM SECTIONAL AREAS</i> .....	18
(m) STEPS IN DOUBLE BOTTOM ( <i>WATER BALLAST</i> ) .....	18
(n) OUTSIDE SHAFT TUNNEL EXCLUSION AND <i>OTHER RECESSES</i> .....	19
(o) OPEN VESSELS .....	19
(p) <i>GENERAL REQUIREMENTS ON ORDINARY FRAMES</i> .....	19
(q) <i>UNCONVENTIONAL HULL FORMS</i> .....	33
<b>69.111 BETWEEN-DECK TONNAGE</b> .....	<b>37</b>
(a) <i>BETWEEN-DECK TONNAGE</i> DEFINED.....	37
(b) IDENTIFYING THE LINE OF THE UPPERMOST COMPLETE DECK.....	38
(c) METHOD OF CALCULATING TONNAGE.....	38
<b>69.113 SUPERSTRUCTURE TONNAGE</b> .....	<b>39</b>
(a) <i>SUPERSTRUCTURE TONNAGE</i> DEFINED.....	39
(b) METHOD OF CALCULATING TONNAGE .....	39
(c) <i>TREATMENT OF STEPPED DECKS/SIDES</i> .....	39
(d) <i>COMPUTING SUPERSTRUCTURE TONNAGE</i> .....	39
(e) <i>TREATMENT OF SPACES OPEN TO UNDER-DECK</i> .....	40
(f) <i>METHOD OF CALCULATING TONNAGE (STANDARD SHAPES)</i> .....	40
<b>69.115 EXCESS HATCHWAY TONNAGE</b> .....	<b>40</b>
(a) <i>APPLICABILITY</i> .....	40
(b) <i>METHOD OF CALCULATING TONNAGE</i> .....	40
(c) <i>DETERMINING EXCESS HATCHWAY TONNAGE</i> .....	40
<b>69.117 SPACES EXEMPT FROM INCLUSION IN GROSS TONNAGE</b> .....	<b>40</b>
(a) PURPOSE.....	40
(b) SPACES ON OR ABOVE THE LINE OF THE UPPERMOST COMPLETE DECK .....	40
(c) PASSENGER SPACES.....	41
(d) OPEN STRUCTURES.....	43
(e) OPEN SPACE BETWEEN THE SHELTER DECK AND THE NEXT LOWER DECK .....	56
(f) WATER BALLAST SPACES .....	57
(g) METHODS FOR MEASURING EXEMPT SPACES.....	58

**69.119 SPACES DEDUCTED FROM GROSS TONNAGE .....61**

- (a) PURPOSE..... 61
- (b) GENERAL ..... 61
- (c) ANCHOR GEAR ..... 61
- (d) BOATSWAIN’S STORES..... 61
- (e) CHART ROOM..... 61
- (f) DONKEY ENGINE AND BOILER..... 61
- (g) SPACES FOR THE EXCLUSIVE USE OF OFFICERS OR CREW ..... 62
- (h) MASTER’S CABIN ..... 62
- (i) RADIO ROOM..... 62
- (j) STEERING GEAR ..... 62
- (k) GENERATORS..... 63
- (l) PUMP ROOM ..... 63
- (m) SAIL STOWAGE..... 63
- (n) WASTE MATERIAL SPACE ..... 63
- (o) PASSAGEWAYS ..... 63
- (p) MARKINGS FOR DEDUCTIBLE SPACES..... 63
- (q) METHOD FOR MEASURING DEDUCTIBLE SPACES ..... 64

**69.121 ENGINE ROOM DEDUCTION.....64**

- (a) GENERAL..... 64
- (b) PROPELLING MACHINERY SPACES..... 64
- (c) METHODS FOR MEASURING PROPELLING MACHINERY SPACES..... 65
- (d) *ENGINE ROOM SPACES ABOVE LINE OF THE UPPERMOST COMPLETE DECK*..... 66
- (e) CALCULATING THE ENGINE ROOM DEDUCTION ..... 67

## STANDARD MEASUREMENT SYSTEM (46 CFR 69 SUBPART C)

### 69.101 PURPOSE

This subpart prescribes the procedures for measuring a vessel under the Standard Measurement System described in 46 U.S.C. 14512.

### 69.103 DEFINITIONS

As used in this subpart -

**BETWEEN-DECK** means the space above the line of the tonnage deck and below the *line of the uppermost complete deck*. The term "between-deck" is also used to refer to the space between enumerated decks that are above the tonnage deck, such as the space between the tonnage deck and the next enumerated deck above. Refer to §69.109(d) for requirements on enumerated decks.

**BREAK** means the space between the line of a deck and the upper portion of that deck, in cases where that deck is stepped and continued at a higher elevation.

**CAMBER** means the perpendicular rise or crown of a deck at the centerline of the vessel measured above the skin of the vessel at the vessel's sides.

**CEILING** means the permanent planking or plating fitted directly on the inboard side of frames, floors, or double bottom and includes cargo battens and refrigeration insulation but does not include false ceiling which stands off from the framing.

**COAMING** means both the vertical plating around a hatch or skylight and the sill below an opening in a bulkhead.

**DECKHOUSE** means a structure that is on or above the uppermost complete deck and that does not extend from side to side of the vessel. The term includes cabin trunks and closed-in spaces over the holds of vessels.

**DEPTH OF FRAME** means the perpendicular depth of a bottom frame and the athwart distance between the inboard and outboard faces of a side frame.

**DOUBLE BOTTOM (WATER BALLAST)** means a space at the bottom of a vessel between the inner and outer bottom plating and used solely for water ballast. *For the space to be considered a double bottom (water ballast), the inner bottom plating must be completely watertight (except for openings to contiguous tanks that are above) and extend continuously fore and aft (interrupted only by peak tanks, cofferdams, and engine rooms) and transversely from one side of the vessel's hull to the other. All accesses to the double bottom (water ballast) must also be watertight.*

**FLOOR** means a vertical plate or timber extending from bilge to bilge in the bottom of a vessel. In a wooden vessel, "floor" means the lowermost timber connecting the main frames at the keel when that timber extends the full depth of the frames to which it is fastened. In a double bottom, floors usually extend from the outer to the inner bottom.

**GROSS TONNAGE** is defined in §69.107(a).

**HATCH** means an opening in a deck through which cargo is laden or discharged.

**LINE OF THE ORDINARY FRAMES** means the line of intersection of: 1) the imaginary surface running longitudinally that is tangent to the inboard faces of the ordinary frames (or the inside of the vessel's skin, if there are no ordinary frames); and 2) the imaginary plane running transversely through the vessel at the tonnage station of interest, following the application of adjustments as set forth in §69.109(p) and (q). The line established before such restrictions are applied is referred to as the unadjusted line of the ordinary frames. The imaginary surface is derived by using flat surfaces to connect the centerlines of the frame faces.

**LINE OF THE TONNAGE DECK** means the line determined under §69.109(e).

**LINE OF THE UPPERMOST COMPLETE DECK** means the line determined under §69.111(b).

**NET TONNAGE** is defined in §69.107(b).

**NORMAL FRAMES** are the smallest frames (i.e., frames with the smallest "depth of frame") used to stiffen a structure.

**ORDINARY FRAMES** are the primary floors used to strengthen the hull

**ORDINARY FRAMES** are the primary frames used for strengthening the hull.

**PARTIAL DECK** is any deck that does not extend from stem to stern and from side to side at all points along its length (as is the case with a "platform" deck that can be accessed only by ladders leading to decks above or below). Portions of decking that rests directly on consecutive or alternating ordinary bottom floors or frames ("ceiling on floors") will cause the decking on either side of the "ceiling on floors" to be considered as partial decks, although oversized ordinary frame openings as described in §69.109(p) will cause the decking above the openings to be treated as if it did not rest on the associated ordinary floor or frame. **NOTE: The presence of a step in a deck will not cause the portions of the deck on either side of the step to be considered partial decks.**

**REGISTERED BREADTH** is defined in §69.53.

**REGISTERED DEPTH** means "molded depth" as defined in §69.53.

**REGISTERED LENGTH** is defined in §69.53.

**SHELTER DECK** means the uppermost deck that would have qualified as the uppermost complete deck had it not been fitted with a middle line opening.

**STEP** means a cutoff in a deck or in the bottom, top, or sides of a space resulting in varying heights of a deck or varying heights or widths of a space.

**SUPERSTRUCTURE** means all the permanent structures (such as forecastle, bridge, poop, deckhouse, and break) on or above the line of the uppermost complete deck or, if the vessel has a shelter deck, on or above the line of the shelter deck.

**TONNAGE DECK** is defined in §69.109(c).

**TONNAGE INTERVAL** means the longitudinal distance between transverse sections of a vessel's under-deck, between-deck or superstructure when divided into an even number of equal parts for purposes of volume integration.

**TONNAGE LENGTH** is defined in §69.109(f).

**UPPERMOST COMPLETE DECK** means the uppermost deck -

- (a) Which extends from stem to stern and from side to side at all points of its length, *and is bounded by the vessel's hull. Decking that is on either side (in the athwartships direction) of the deck discontinuities listed below is not considered to be part of the uppermost complete deck. Such discontinuities will accordingly invalidate the associated deck, or portion thereof, from qualifying as the uppermost complete deck.*
- (1) **Middle Line Openings** *Middle line openings, as described in §69.117(e)(2).*
- (2) **Other Through Deck Openings** *Other through deck openings (e.g., hatchways, elevator shafts, cargo ramps): 1) that are not protected from the sea and the weather, such as would be provided by hatch covers or a surrounding superstructure that encloses the opening; and 2) whose area (as viewed from above) is more than 10% of the total deck area from stem to stern (as viewed from above).*
- (3) **Deck Recesses** *Deck recesses that are not "through hull" (e.g., cockpits and swimming pools): 1) for which the depth of the deck recess at its deepest point is more than 5 feet below adjacent portions of the deck; and 2) whose area (as viewed from above) is more than 10% of the total deck area from stem to stern (as viewed from above). **NOTE: Deck recesses that are "through hull" (i.e. open to sea on the bottom, and bounded on all sides by the vessel's hull, as is the case for certain moon pools) do not invalidate the associated deck from qualifying as an enumerated deck.***
- (4) **Wrap-Around Notches** *Notches bounded by a deck below that "wrap around" from the ends to the sides of the vessel (i.e., past the 45 degree line off the longitudinal axis that is tangent to the hull) for which: 1) the depth of the notch at its deepest point is more than 5 feet below adjacent portions of the deck; and 2) all of the following conditions are met:*
- (i) *the area of the notch (as viewed from above) is more than 1% of the total deck area from stem to stern (as viewed from above);*
- (ii) *the length of the notch in the direction of the vessel's longitudinal axis exceeds 10 feet at any point across its width; and*

(iii) the width of the notch in the direction of the vessel's longitudinal axis exceeds 2 feet at any point along its length.

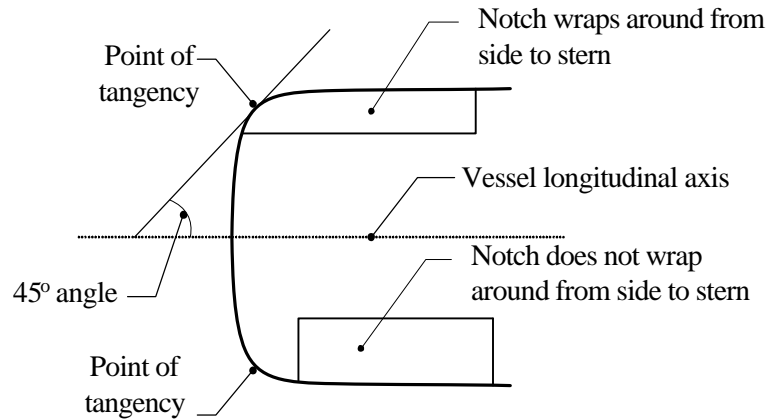

- (b) The space below which is enclosed by the sides of the vessel;
- (c) Through which there is no opening that would exempt the space below from being included in gross tonnage; and
- (d) Below which there is no opening through the hull that would exempt the space below from being included in gross tonnage, as in the case of an opposite side tonnage opening;
- (e) Which remains above the design waterline of the vessel at all points of its length, except in the case of submersibles, dockships and similar vessels, where the entire uppermost complete deck is submerged during normal operations; and
- (f) Which does not rest directly on consecutive or alternating ordinary bottom floors or frames ("ceiling on floors") for a distance of over one-half of the tonnage length, thereby creating partial decks, the total length of which is less than one-half the tonnage length (see § 69.109(o)). **NOTE: While there is an indirect relationship between the one-half of the tonnage length criterion and the number of "zero area" tonnage stations, the criterion must be applied by totaling the lengths of the "ceiling on floors" on either side of the partial decks. Refer to the definition of "partial deck" in § 69.103.**

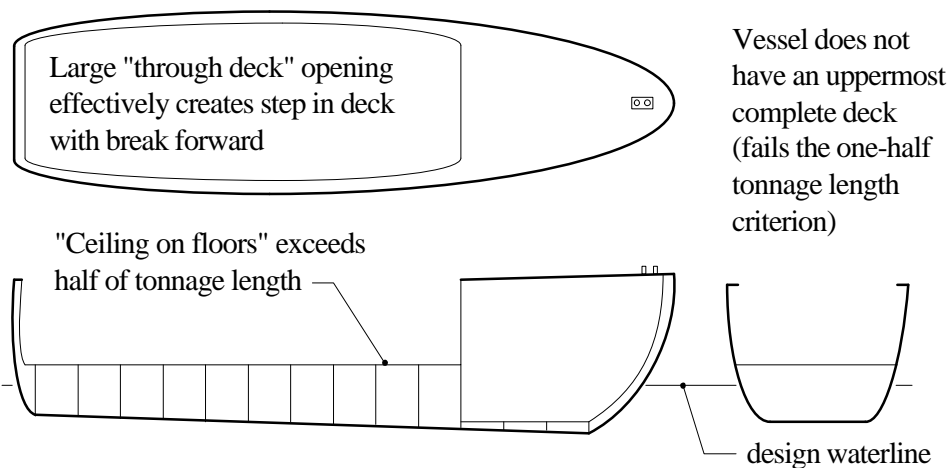

**69.105 APPLICATION FOR MEASUREMENT SERVICES**

Applications for measurement services under this subpart must include the following information and plans:

- (a) Type of vessel.
- (b) Vessel's name and official number (if assigned).
- (c) Builder's name and the vessel hull number assigned by the builder.
- (d) Place and year built.
- (e) Date keel was laid.
- (f) Overall length, breadth, and depth of vessel.
- (g) Lines plan.
- (h) Booklet of offsets.
- (i) Capacity plans for tanks.
- (j) Construction plans showing measurements and scantlings of hull and superstructure.
- (k) Tonnage drawing showing tonnage length in profile and tonnage sections.
- (l) Arrangement plans.

**69.107 GROSS AND NET TONNAGES**

**(a) GROSS TONNAGE**

*Gross tonnage* is the sum of the following tonnages, less certain spaces exempt under §69.117:

- (1) Under-deck tonnage (§69.109).
- (2) Between-deck tonnage (§69.111).
- (3) Superstructure tonnage (§69.113).
- (4) Excess hatchway tonnage (§69.115(c)).
- (5) Tonnage of framed-in propelling machinery spaces included in calculating gross tonnage (§69.121(d)(1)).

**(b) NET TONNAGE**

*Net tonnage* is gross tonnage less deductions under §§69.119 and 69.121.



## 69.109 UNDER-DECK TONNAGE

(a) **DEFINED**

“Under-deck tonnage” means the tonnage of the space below the line of the tonnage deck, as that volume is calculated under this section.

(b) **METHOD OF CALCULATING TONNAGE**

Under-deck tonnage is calculated by applying Simpson’s first rule using the tonnage length and the areas of the tonnage sections prescribed by this section.

(c) **IDENTIFYING THE TONNAGE DECK**

In vessels with two or less *enumerated* decks, the tonnage deck is the uppermost complete deck. In vessels with more than two *enumerated* decks, the tonnage deck is the second *enumerated* deck from the keel as determined in paragraph (d) of this section.

(d) **ENUMERATING THE DECKS TO IDENTIFY THE SECOND DECK FROM THE KEEL**

*The following is used to establish which decks are enumerated decks as described in §69.109(c):*

(1) **Shelter Decks** Only decks without openings that permit space below to be exempt from inclusion in under-deck tonnage are enumerated. *Shelter decks are, therefore, not enumerated.*

(2) **Uppermost Complete Deck** *The uppermost complete deck is an enumerated deck.*

(3) **Interior Decks** *All decks below the uppermost complete deck (“interior decks”) that extend from stem to stern and from side to side at all points of their lengths are enumerated, provided they do not coincide at any point along their length with another deck being enumerated. The following additional requirements apply to enumerated interior decks:*

(i) **Partial Decks** *Partial decks are not considered decks for the purpose of enumerating decks. In addition, any deck that rests directly on consecutive or alternating ordinary bottom floors or frames across the full breadth of the vessel is disqualified from being enumerated, although oversized ordinary frame openings as described in §69.109(p) will cause the decking above the openings to be treated as if it did not rest on the associated ordinary floor or frame. However, the presence of engine and boiler casings, peak tanks, or cofferdams that penetrate a deck do not disqualify the deck from being enumerated*

(ii) **Deck Discontinuities** *The following deck discontinuities will disqualify the deck from being enumerated:*

(1) **Through Deck Openings** *Through deck openings that: 1) are not fitted with covers (or equivalent); and 2) whose area (as viewed from above) is more than 10% of the total deck area from stem to stern (as viewed from above).*

(2) **Deck Recesses** *Deck recesses that are not “through hull” (e.g., cockpits and swimming pools): 1) for which the depth of the deck recess at its deepest point is more than 5 feet below adjacent portions of the deck; and 2) whose area (as viewed from above) is more than 10% of the total deck area from stem to stern (as viewed from above). **NOTE: Deck recesses that are “through hull” (i.e. open to sea on the bottom, and bounded on all sides by the vessel’s hull, as is the case for certain moon pools) do not invalidate the associated deck from qualifying as an enumerated deck, regardless of size.***

(e) **IDENTIFYING THE LINE OF THE TONNAGE DECK**

*In vessels without an enumerated deck, establish the line of the tonnage deck in accordance with §69.109(o). In vessels with one or two enumerated decks, the line of the tonnage deck is the line of the uppermost complete deck, and is established in accordance with §69.111(b). In vessels with more than two enumerated decks, establish the line of the tonnage deck as indicated below.*

- (1) **Deck Runs in Continuous Line Longitudinally** If the tonnage deck runs in a continuous line from stem to stern, the line of the tonnage deck is the longitudinal line at the underside of the tonnage deck.
- (2) **Deck Runs at Different Levels Longitudinally** If the tonnage deck runs at different levels from stem to stern (*i.e., longitudinally stepped*), the line of the tonnage deck is the longitudinal line of the underside of the lowest portion (*i.e., lowest longitudinal step*) of that deck parallel with the upper portions of that deck. *A longitudinal step being used as the basis for establishing the line of tonnage deck must have a length of at least 3 feet in the direction of the vessel's longitudinal axis extending across the full breadth of the vessel at the location of the step. Deck discontinuities that are ignored when establishing which deck is the tonnage deck are similarly ignored when establishing the vertical location of the line of the tonnage deck. NOTE: Spaces between the line of the tonnage deck and the higher portions of that deck are not included in under-deck tonnage; rather, they are included in the between-deck or superstructure tonnage, as appropriate.*

(f) **TONNAGE LENGTH**

- (1) **General** "Tonnage Length" means the length of a horizontal straight line measured at the centerline of the vessel from the point forward where the line of the tonnage deck intersects the line of the inboard faces of the ordinary side frames to the point aft where the line of the tonnage deck intersects the inboard face of the *ordinary* transom frames or cant frames.

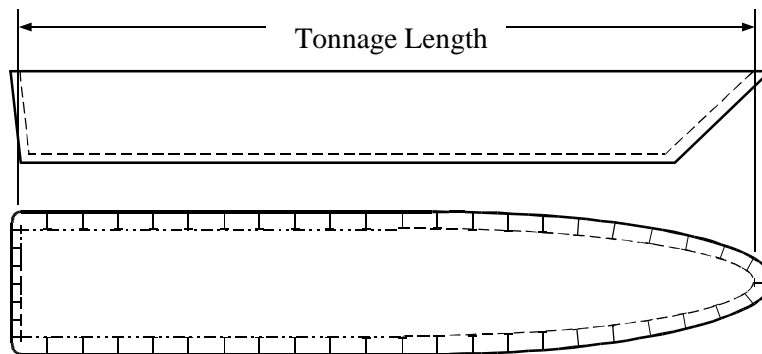

The following additional requirements apply:

- (i) Complex Stem / Stern Geometries For vessels with complex hull geometries at the extreme ends (e.g., SWATHs, monohulls with bulbous bows, etc.), the tonnage length is terminated on an imaginary plane that is perpendicular to the longitudinal axis of the vessel and tangent to the imaginary surface bounding the inboard faces of the ordinary frames at the extreme fore and aft location of this surface.

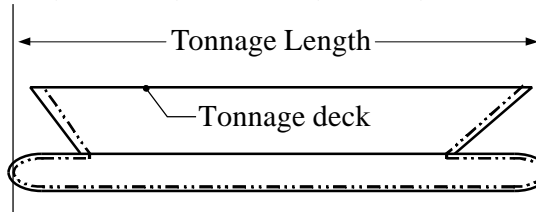

- (ii) “Deep Framed” Sections If the last two ordinary side frames (or alternating ordinary side frames) at the bow/stern of the vessel are solid side-to-side “deep” frames (no sectional area), then the tonnage length is terminated at the location where the vertical plane on the longitudinal axis of the vessel intersects the imaginary surface that is tangent to the inboard faces of the ordinary stem, stern or cant frames at the line of the tonnage deck. In the absence of ordinary stem, stern or cant frames, the tonnage length is terminated on the inside of the vessel’s skin at the extreme end of the vessel.

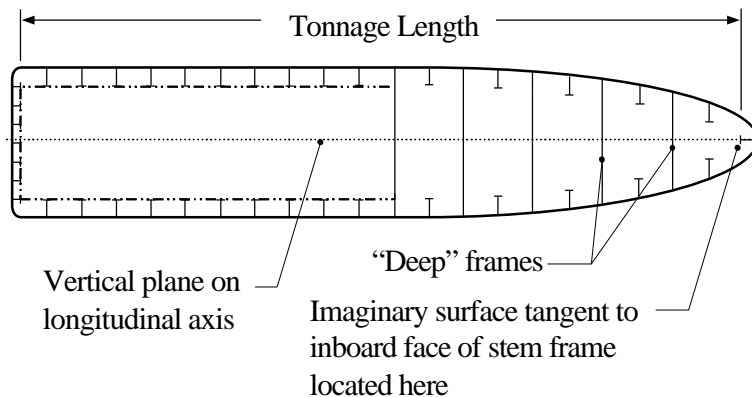

- (2) **Vessel With Headblock or Square End** For a vessel with a headblock or square end with framing which extends from the tonnage deck to the bottom of the vessel, the tonnage length terminates on the inboard face of the head block or end framing. When a headblock extends inboard past the face of the end frames or side frames, or when the headblock plates are excessive in length, the tonnage length terminates at the extreme end of the vessel less a distance equal to the thickness (i.e., depth) of an ordinary side frame and shell plating. Headblock plates are longitudinal structural plates at the extreme ends of the vessel that do not qualify as ordinary frames. In order to be considered "excessive in length" the headblock plate length is such that the presence of such a plate would cause a decrease in the tonnage length from that which would have been obtained were the plates not installed.

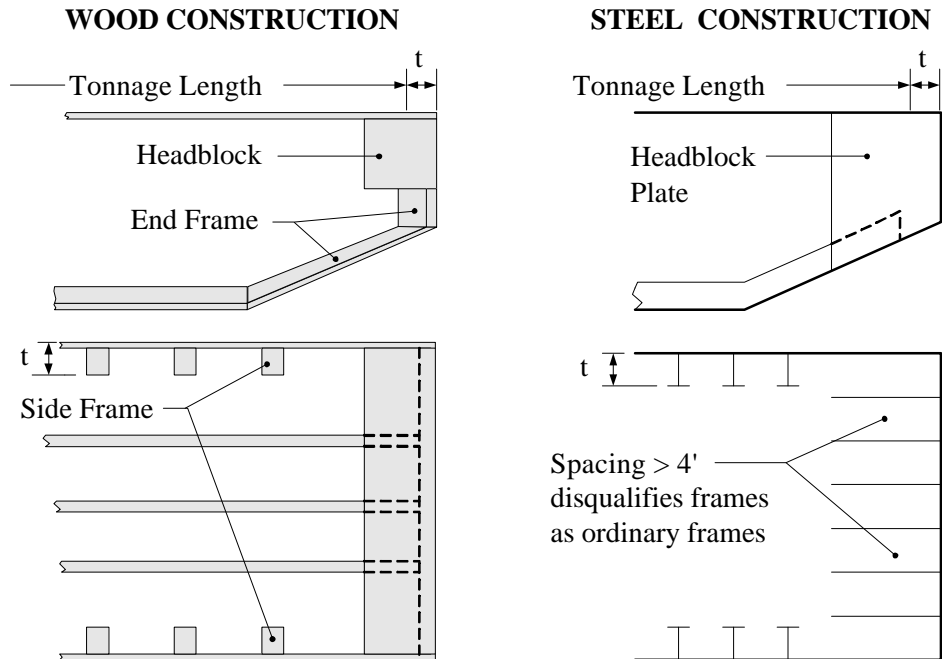

- (3) **Camber** For a vessel having a square bow or stern and tonnage deck with camber, the effect of the camber on the tonnage length must be considered. The tonnage length must be measured below the tonnage deck at a distance equal to one-third of round camber and one-half of straight pitch camber.

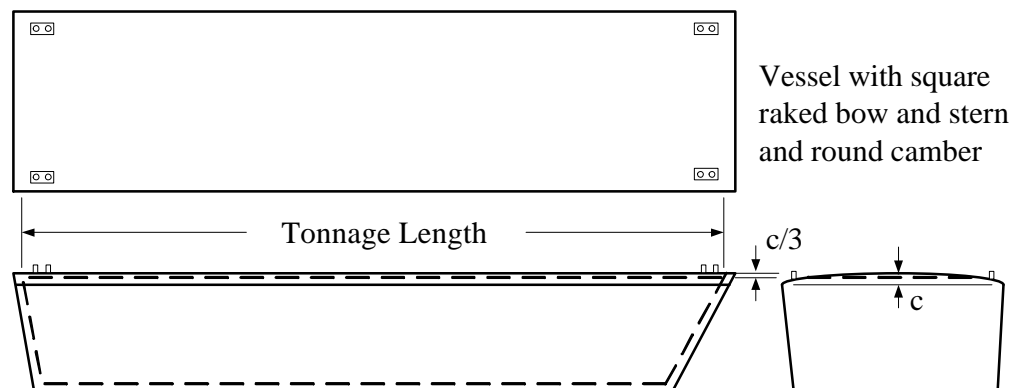

- (4) **Restrictions on Termination Points** The following restrictions apply to the tonnage length termination points:

- (i) The horizontal distance in the longitudinal direction from the termination point to the associated inboard surface of the skin of the hull at the bow or the stern cannot exceed 8.5 feet.

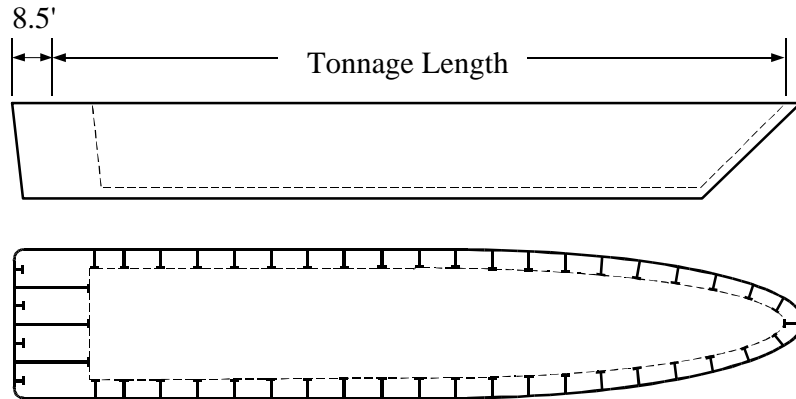

- (ii) The forward termination point must be forward of the intersection of the centerline and face of the foremost transverse ordinary frame; and

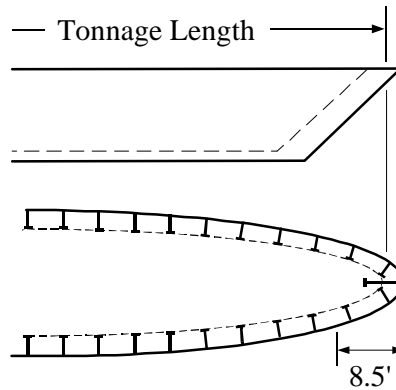

- (iii) The after termination point may not be located forward of either: 1) the intersection of the centerline and face of the aftermost transverse ordinary frame; or 2) the forward side of the rudder stock (excepting vessels with exterior rudder stocks).

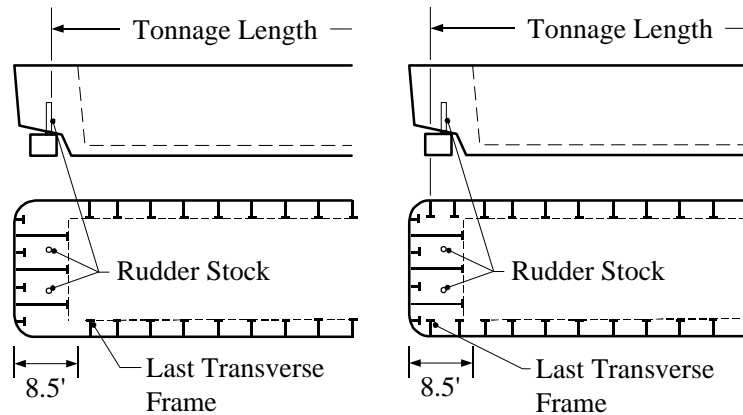

**(g) DIVISION OF VESSEL INTO TRANSVERSE SECTIONS**

**(1) Number of Divisions** Except as under paragraph (m)(1)(iii) of this section, the tonnage length is divided into an even number of equal parts as indicated in the following table:

CLASS	TONNAGE LENGTH (FT)	DIVISIONS	STATIONS
1	$L \leq 50$	6	7
2	$50 < L \leq 100$	8	9
3	$100 < L \leq 150$	10	11
4	$150 < L \leq 200$	12	13
5	$200 < L \leq 250$	14	15
6	$L > 250$	16	17

**(2) Location of Stations** Transverse sections are cut at each end of the tonnage length and at each point of division of the tonnage length. Intervals and one-third intervals (*defined in paragraph (k)(5) of this section*) between the points of division are measured to the nearest thousandth of a foot.

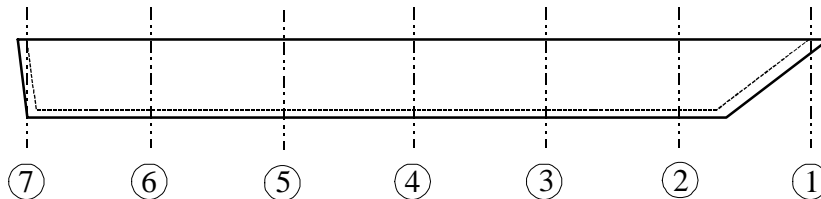

(h) DEPTHS OF TRANSVERSE SECTIONS (see also §69.109(p) and (q))

- (1) **General** Transverse section depths are measured at each point of division of the tonnage length at the centerline of the vessel from a point below the line of the tonnage deck equal to one-third of the camber or to one-half of the pitch of the beam down to the lowest portion of the upper side of the ordinary frames, floors, longitudinals, or tank top of a cellular or other qualifying double bottom (water ballast), as the case may be. Floors and longitudinals in this context are specific types of ordinary frames. If no frames qualify as ordinary frames, depths are terminated at the inner surface of the hull shell.

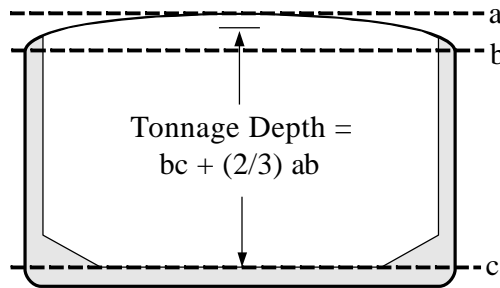

- (2) **Tank Top Fall** When a depth falls at a point where the tank top of a double bottom (water ballast) has a straight fall from centerline to the wings, the depth terminates at one-half of the height of fall.

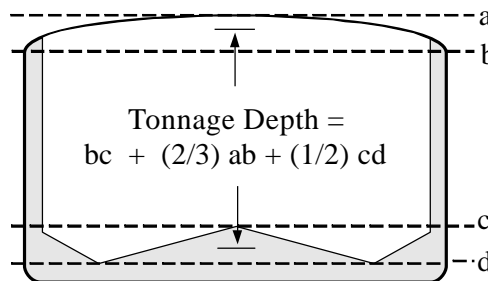

- (3) **Tank Top Rise** When a depth falls at a point where the tank top of a double bottom (water ballast) rises from the centerline to the wings, the depth terminates at one-half the dead rise.

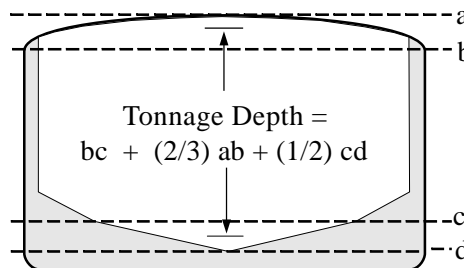

- (4) **Number of Depth Increments** The depth at the midpoint of the tonnage length or, when a vessel is measured in parts, the depth at the midpoint of each part determines the number of equal parts into which each depth is divided, as follows:

- (i) Midpoint Depth Criterion If the midpoint depth is 16 feet or less, each depth is divided into four equal parts. If the midpoint depth exceeds 16 feet, each depth is divided into six equal parts.

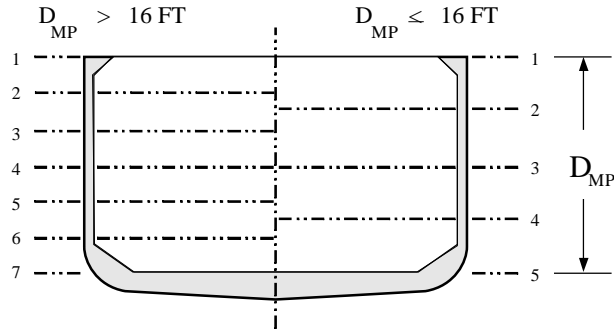

- (ii) Rounding The interval between the points of division of a depth and one-third intervals are carried to the nearest hundredth of a foot.

(i) **BREADTHS OF TRANSVERSE SECTIONS** (see also §69.109(p) and (q))

- (1) **General** Transverse section breadths are measured horizontally at each point of division of each depth and also at the upper and lower points of each depth. Breadths are measured to the inboard face of the ordinary frames or to the line of the ordinary frames. Breadths are measured parallel to each other and at right angles to the vessel's centerline.

Transversely Framed Vessel

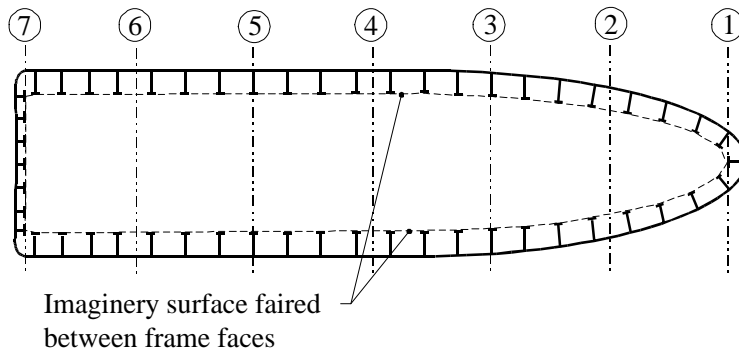

Longitudinally Framed Vessel

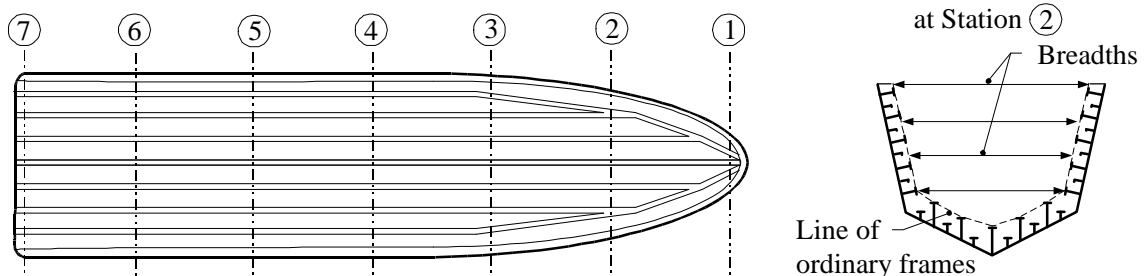



- (2) **Deck Brackets and Camber** Upper breadths are not reduced by measuring to deck-beam brackets. In cases of camber where an upper breadth passes through the deck, the breadth is measured to the line of the side frames at the underside of the deck projected vertically up to the height of the upper breadth.

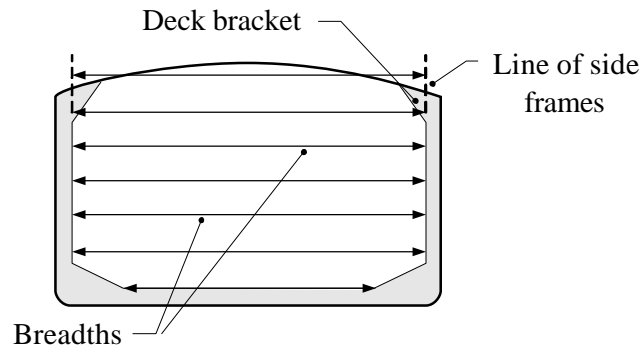

- (3) **Dead Rise** Bottom breadths are measured only as far as the flat of the floor extends. When bottom frames rise immediately from the flat keel, bottom breadths are equal to the breadth of the flat keel. Where there is no double bottom (*water ballast*) and where there is dead rise of the bottom out to the sides of the vessel, bottom breadths are equal to the part of the bottom plating not affected by dead rise.

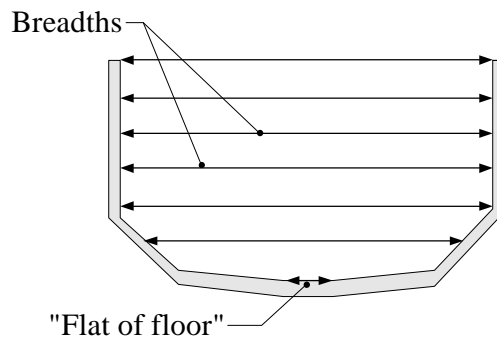

- (4) **Sloping Double Bottom (Water Ballast)** Bottom breadths falling in way of a double bottom (*water ballast*), the top of which rises or falls from centerline to the wings, are measured between the inboard faces of the frame brackets which connect the double bottom (*water ballast*) with the frames.

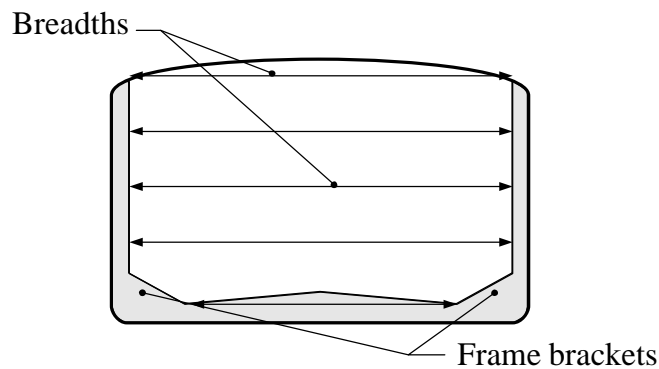

**(j) MEASURING SPACES HAVING CEILING**

The maximum allowance for terminating measurements on ceiling is three inches on the bottom frames or tank top and three inches on each side frame. When ceiling is less than three inches thick, only the actual thickness is allowed. When ceiling is fitted on a platform directly above the bottom frames, depths are measured down through the platform to the upper side of the frames and the allowable ceiling on the platform is then deducted.

**(k) AREA OF TRANSVERSE SECTIONS**

*Areas at each transverse section are calculated as follows:*

- (1) Areas at Extremities of Tonnage Length** A transverse station at the end of the tonnage length may not yield area, except in vessels (such as barges) with an upright bow or stern.
- (2) Numbering of Breadths** The breadths of each transverse section are numbered from above, the upper being "1", the second being "2", and so on to the lowest.
- (3) Applying Multiplication Factors** Multiply the even numbered breadths by four and the odd numbered breadths by two, except for the first and last breadths, which are multiplied by one.
- (4) Summing Products** Add together the products from paragraph (k)(3) of this section.
- (5) Final Area Calculations** Multiply the sum from paragraph (k)(4) of this section by one-third of the interval between the breadths. The product is the area of the transverse section.

**(l) CALCULATING TONNAGE FROM SECTIONAL AREAS**

*The total under-deck volume and tonnage is calculated as follows, using the areas determined in paragraph (k)(5) of this section:*

- (1) Numbering Stations** Number the transverse sections successively "1", "2", and so forth, beginning at the bow.
- (2) Applying Simpson's Multipliers** Multiply the area of the even numbered sections by four and the area of the odd numbered sections by two, except the first and last sections, which are multiplied by one.
- (3) Completing Volume Calculations** Add together the products from paragraph (l)(2) of this section and multiply the sum by one-third of the interval between the sections. The product is the volume under-deck.
- (4) Converting to Tonnage** The volume under-deck is divided by 100 and is, subject to exemptions, the under-deck tonnage.

**(m) STEPS IN DOUBLE BOTTOM (WATER BALLAST)**

*This section provides general requirements for measurement "in parts" of vessels of monohull vessels having stepped double bottoms (water ballast) where the height of the step(s) exceeds six inches.*

- (1) Division into Parts** The tonnage length of a vessel having a step exceeding six inches in height in its double bottom (*water ballast*) is divided into longitudinal parts at the step. Each part is subdivided as follows to determine the number of transverse sections:

- (i) Parts 20 feet or under in length are divided into two equal parts.
  - (ii) Parts over 20 feet and under 40 feet in length are divided into four equal parts.
  - (iii) Parts 40 feet or over are divided as provided in paragraph (g)(1) of this section.
- (2) **Summation of Tonnages** The tonnage of each part is calculated separately. The sum of the tonnages of the parts is the under-deck tonnage.

**(n) OUTSIDE SHAFT TUNNEL EXCLUSION AND OTHER RECESSES**

Any portion of an outside shaft tunnel *or other recess in the hull that is included in tonnage through the process of measurement is subtracted from the under-deck or between-deck tonnage. This is done using the procedure of §69.109(q)(7) by subtracting out portions of breadth measurements that are outside the hull. NOTE: There are no provisions for similarly subtracting from tonnage the volume of those portions of deck recesses that are below the line of the uppermost complete deck.*

**(o) OPEN VESSELS**

- (1) **Definition** An open vessel is one of any length without a deck or with one or more partial decks, the total length of which is less the one-half the tonnage length. *In other words, an open vessel is one without an uppermost complete deck.*
- (2) **Line of the Tonnage Deck** The line of the tonnage deck for an open vessel is the upper edge of the upper strake. Depths of transverse sections are taken from this line.
- (3) **Restrictions on Smaller Vessels** Any vessel, other than one having a mechanically refrigerated hold, that is not an open vessel and that has a tonnage length of less than 50 feet is measured as an open vessel, if the distance between the line of its tonnage deck and the upper edge of the upper strake is more than one-sixth of the midship depth. “Midship depth” means the depth measured from the line of the upper edge of the upper strake to the point in the bottom used for measuring tonnage depths.

**(p) GENERAL REQUIREMENTS ON ORDINARY FRAMES**

*This section provides general requirements on ordinary frames. The ordinary frames must first be identified and the line of the ordinary frames established in order to determine depth and breadth measurements under §69.109 (h) and (i).*

- (1) **Ordinary Frame Construction** *The following apply to the construction of ordinary frames and floors:*
- (i) **Frame Intersection** *A frame may not be considered to be an ordinary frame if it is penetrated by an intersecting frame (or other structural element such as plating) that is used to strengthen the vessel’s hull, except in the case of floors in vessels of wooden construction. In wooden vessels, an ordinary floor may be penetrated by an intersecting frame, provided it is attached to the intersecting frame. In vessels of other than wooden construction, an ordinary frame may be penetrated by an intersecting frame when initially assembled, provided subsequent manufacturing steps are taken to render the final assembly to appear as an integral unit (such as by continuous welding).*

**NOTE:** *The practice of allowing one longitudinal side frame and one longitudinal bottom frame to penetrate a transverse ordinary frame in vessels of other than wooden construction is no longer authorized.*

- (ii) Material Ordinary frames must be of the same material as the adjacent hull. If a portion of the frame is not of the same material as the adjacent hull, that portion is treated as if it were not there for purposes of establishing breadth and depth measurements. The Marine Safety Center will consider written requests for exceptions to this requirement, if it can be demonstrated that the frame material strength equals or exceeds the hull material strength.

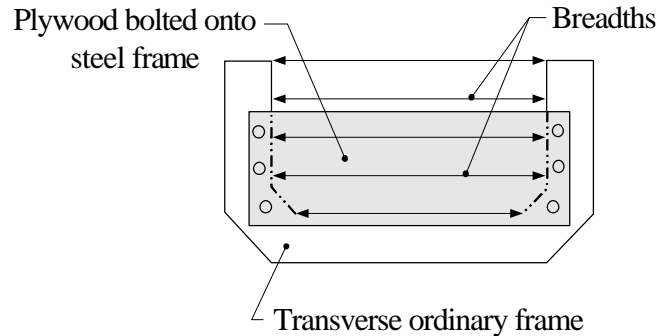

- (iii) Attachment to Hull Each frame must attach to the hull to at least the same extent as adjacent ordinary and normal framing. For example, if an adjacent ordinary frame is attached to the hull with a continuous fillet weld on both sides of the web, the frame in question must also be attached to the hull with a continuous fillet weld on both sides of the web. If this criterion is not met, then the entire frame may not be considered as an ordinary frame.
- (iv) Framing Comprised of Different Elements If an ordinary frame is comprised of different distinct elements, those elements must be permanently bonded together (e.g., welded, glued or bolted) to form a continuous and integral unit. Individual components must be attached to each other in the same (or equivalent) manner and to the same extent that the frame is joined to the hull. If an element of the frame does not meet any of these criteria, that element is treated as if it were not there for purposes of establishing breadth and depth measurements.

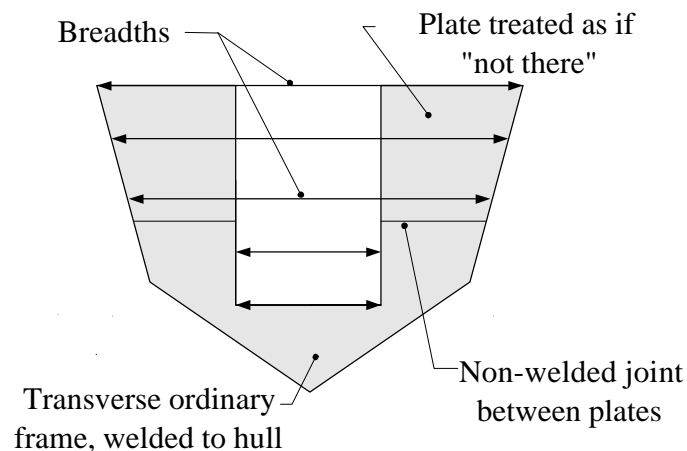

**NOTE:** *There are no longer any restrictions on the relative thicknesses of the different frame elements.*

(2) **Transverse Framing** *The following additional requirements apply to those vessels fitted with transverse ordinary frames:*

(i) **General Requirements** *In order to be used as the basis for establishing the line of the ordinary frames, the ordinary frames must be spaced on centers that are a maximum of four (4) feet apart for a length of at least one tonnage interval ( $L_{TI}$ ) either crossing, beginning at, or ending at the tonnage station of interest. Otherwise, the line of the ordinary frames is taken at the inboard surface of the skin of the hull at the tonnage station of interest.*

Example 1

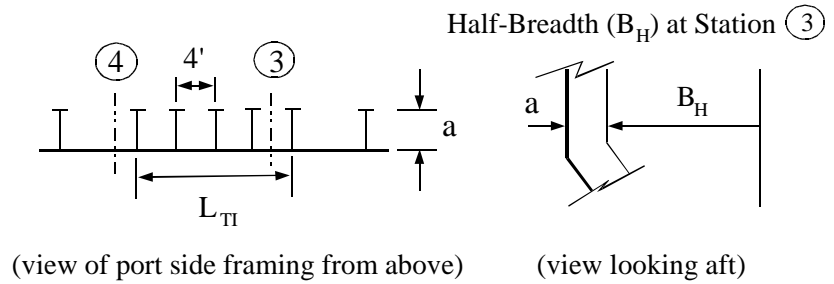

Example 2

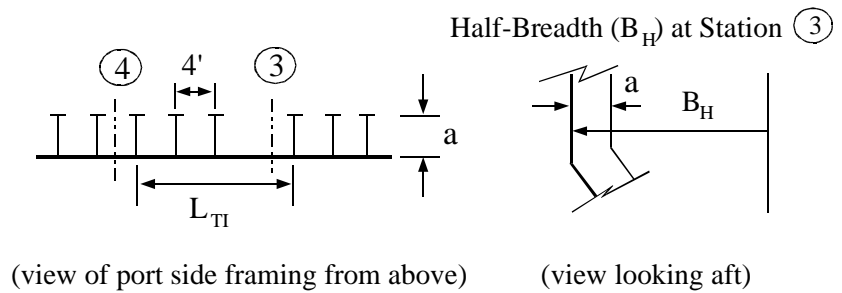

(ii) Different Sized Framing If the ordinary frames are of different sizes (i.e., differing “depths of web”), the line of ordinary frames is established using the largest sized ordinary frames that alternate with smaller or equal sized ordinary frames for a length of at least one tonnage interval ( $L_{TI}$ ) either crossing, beginning at, or ending at the tonnage station of interest. If the alternating larger frames are not of equal size, then the smallest frame of the selected set of alternating larger ordinary frames is used to establish the line of the ordinary frames.

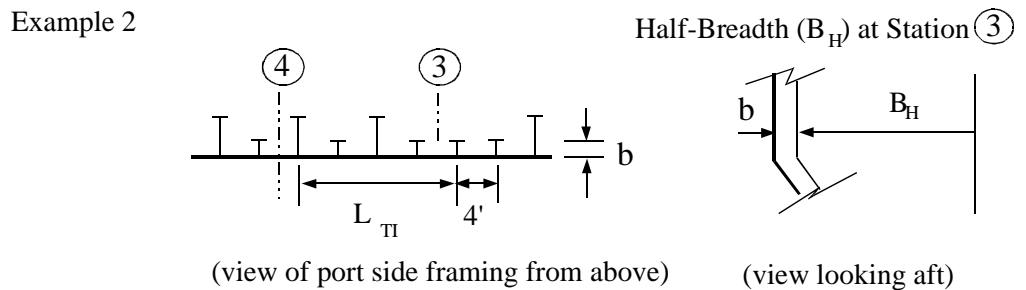
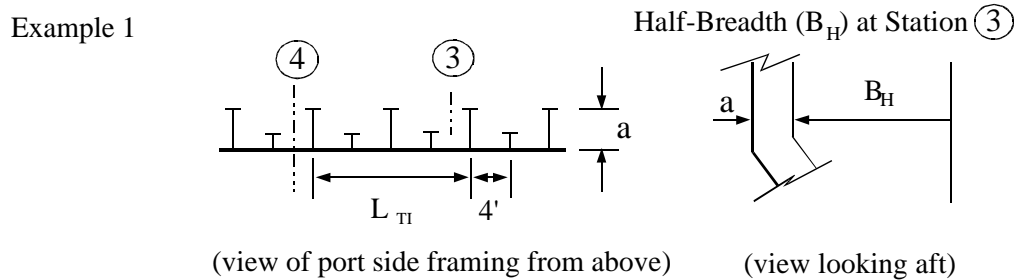

(iii) Openings If an opening in an ordinary frame (e.g., lightening hole) exceeds a diameter of 18" (all locations except fuel tanks) or a size of 15" wide by 23" high (fuel tanks only), the opening is considered to be oversized, and the line of the ordinary frames is established as if the frame material above and inboard of the opening were not there.

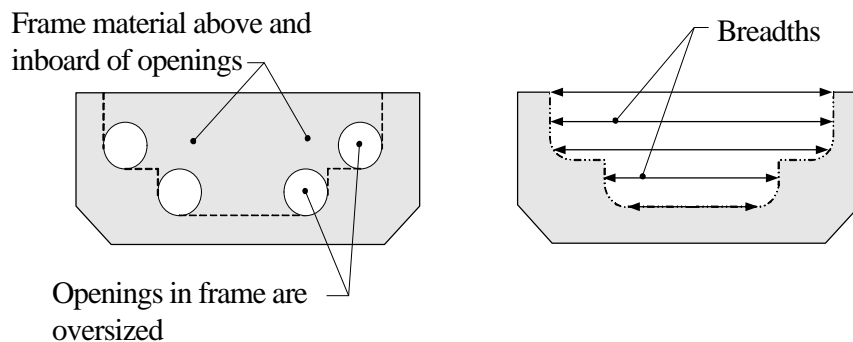

*Piping, ventilation, cabling, shafting and similar items of a non-structural nature may be run through the openings without affecting breadth measurements. The following specific interpretations regarding ordinary frame openings also apply:*

- (1) Equivalent Sized Openings To determine whether openings of different shapes are oversized openings as defined in §69.109(p)(2)(iii) above, calculate the areas of the openings. Openings that are larger than 254.5 square inches (all locations except fuel tanks) or 345 square inches (fuel tanks only) are treated as oversized openings. **NOTE: These areas relate to the size criteria of §69.109(p)(2)(iii). The 254.5 square inch area for all locations except fuel tanks is equivalent to the 18" diameter criterion and the 345 square inch area for fuel tanks only is equivalent to the 15" wide by 23" high criterion.**

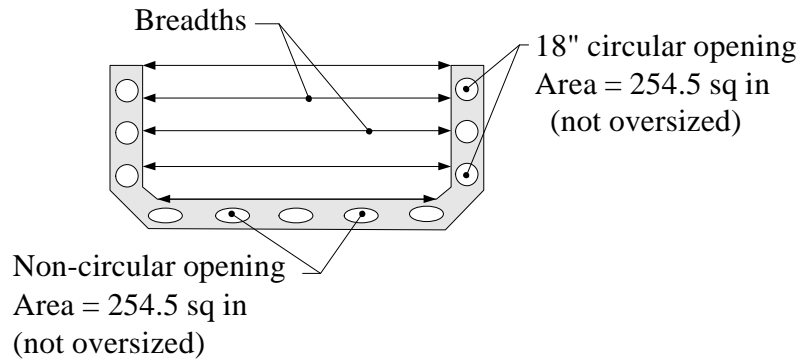

- (2) Proximity of Openings Except as permitted by §69.109(p)(2)(iii)(4), frame openings that are within the longest linear dimension of any adjacent opening are treated as if the frame material separating the openings were not there.

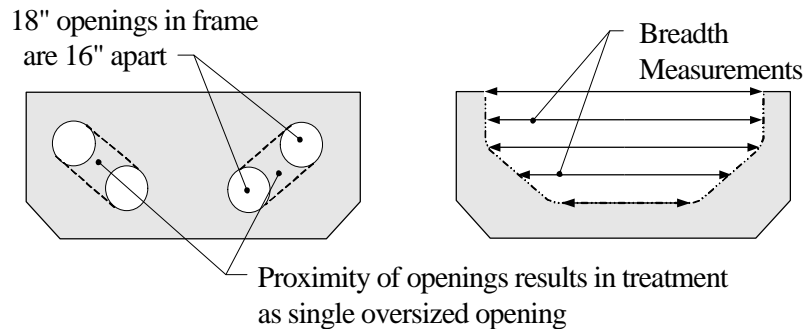

- (3) Location of Openings Openings that are not oversized may be situated in any location within, or along the outboard edge of, the frame without affecting the line of the ordinary frames. A “notch” at the upper edge of a deep transverse frame is considered to be an opening “within” the frame when there is decking present that effectively serves as the flange for the web.

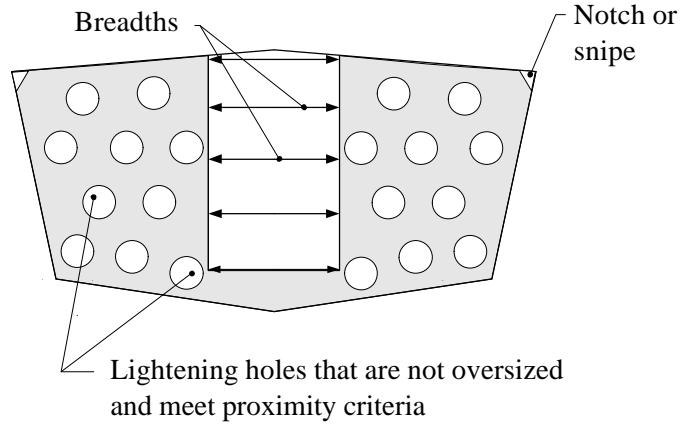

- (4) Strapping The attachment of a single strap across an oversized opening is considered an acceptable method of reducing the size of the opening. The final “strapped” configuration must meet all of the requirements of §69.109(p)(1) and §69.109(p)(2)(iii)

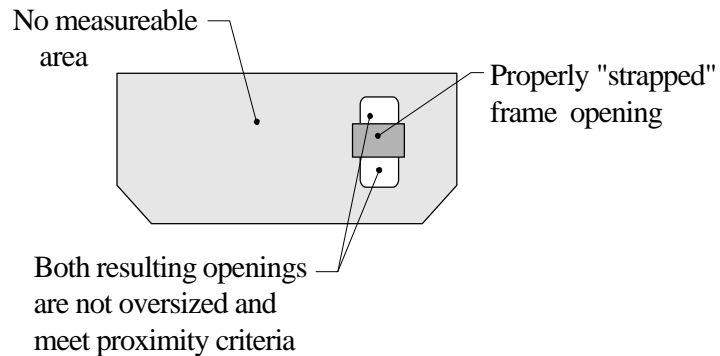

**NOTE:** Use of a single 1” wide strap is no longer an acceptable method of reducing the size of an oversized opening.



- (5) *Intersecting Structural Members* If a structural member passes through an opening that is not oversized, that opening shall be treated in the same manner as an opening that is oversized. Under the requirements of §69.109(p)(1)(i), an intersecting structural member that is used to strengthen the vessel's hull would preclude the frame from being considered as an ordinary frame, regardless of opening size, if it passes through the frame opening.

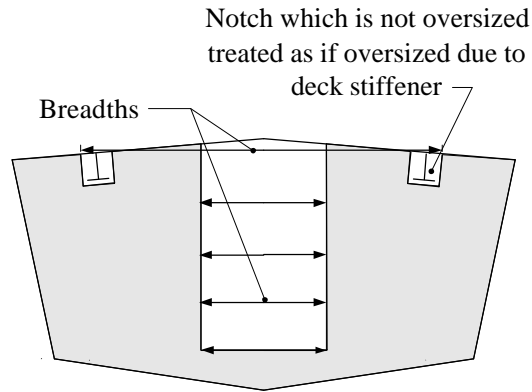

- (iv) *Vertical Continuity of Framing* In order to be considered an ordinary side frame, the frame must extend from the turn of bilge up to the line of the tonnage deck, with a measurable "depth of frame" at all points along its length. If the former condition is not met, the portion of a side frame above the turn of bilge is treated as if it were not there.

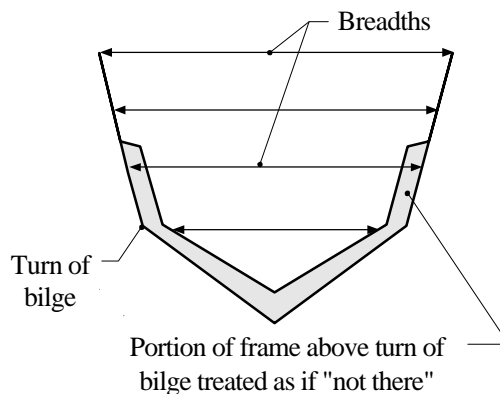

**NOTE:** Requirements of §69.109(p)(4) on attachment of transverse bottom floors or framing to ordinary side frames preclude alternating transverse side frames and bottom floors from being considered as ordinary frames.

- (v) Adjustments to the Line of the Ordinary Frames Except in situations involving tumblehome, the line of the ordinary frames is established as if the portions of frames that are above and inboard of the outboard most point along the unadjusted line of the ordinary frames were not there. In situations involving tumblehome, the line of the ordinary frames should “follow the hull” above this outboardmost point.

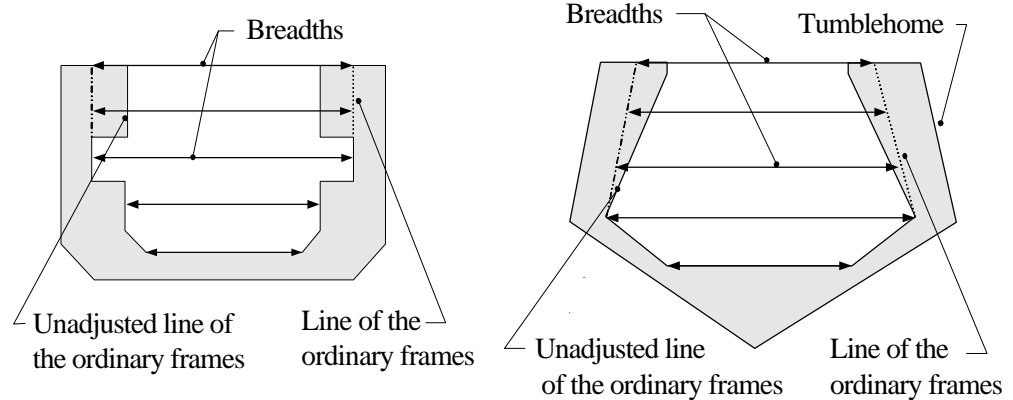

(3) **Longitudinal Framing** The following apply to vessels fitted with longitudinal ordinary frames:

- (i) General Requirements In order to be used as the basis for establishing the line of the ordinary frames, the ordinary frames must be spaced on centers that are a maximum of four (4) feet apart, and must begin and end at a transverse ordinary frame or at the vessel's hull. The framing must run the length of at least one tonnage interval ( $L_T$ ) either crossing, beginning at, or ending at the tonnage station of interest. If these requirements are not met, the line of the ordinary frames is taken at the inboard surface of the skin of the hull at the tonnage station of interest. Also, if the uppermost ordinary frame is below but within 4 feet of the line of the tonnage deck, the upper portion of the line of the ordinary frames is taken as the continuation of the line drawn between the faces of the upper two ordinary frames (before applying any adjustments under §69.109(p)(3)(vii)).

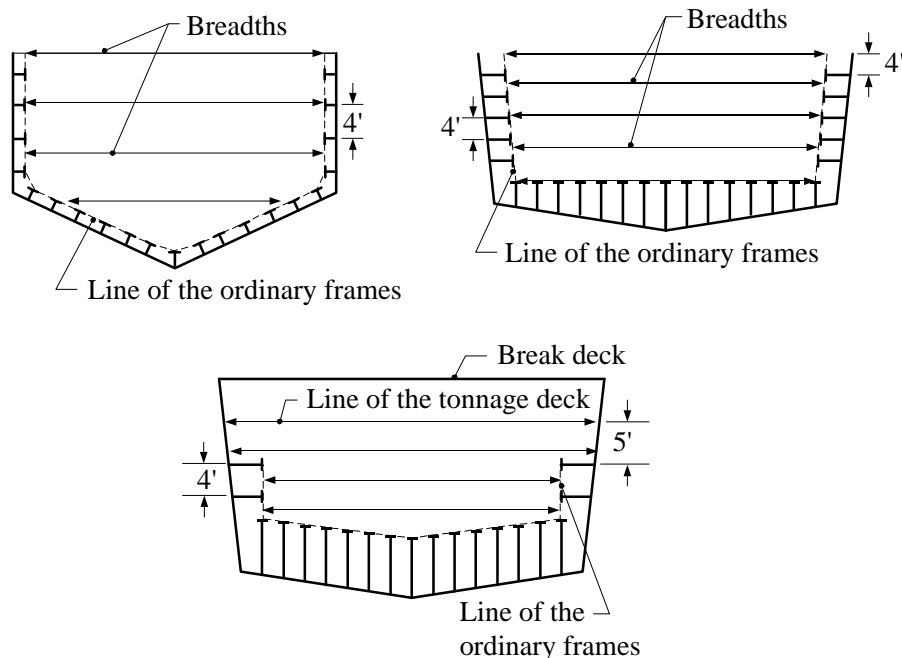

**NOTE:** There are no restrictions regarding the size of ordinary side frames.

(ii) Different Sized Framing If the ordinary frames are of different sizes (i.e., differing “depths of frame”), the set of alternating frames that yields the smallest sectional area at the associated tonnage station is used to establish the line of the ordinary frames. Different sets of bottom frames and side frames may be selected in order to yield the smallest sectional area, provided there are at least two alternate ordinary frames in each set.

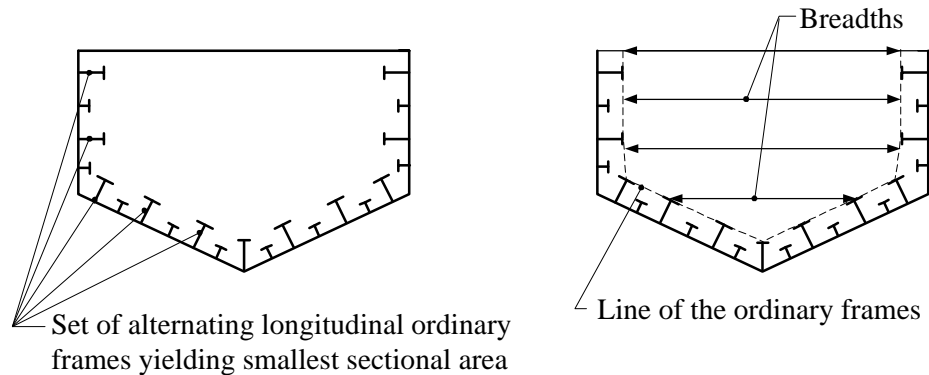

(iii) Frame Openings The size and spacing requirements of §69.109(p)(2)(iii) for openings in transverse ordinary frames also apply to openings in longitudinal ordinary frames. If these requirements are not met, the line of the ordinary frames is established as if the portion of the frame above and/or inboard of the outboard-most edge of the opening were not there.

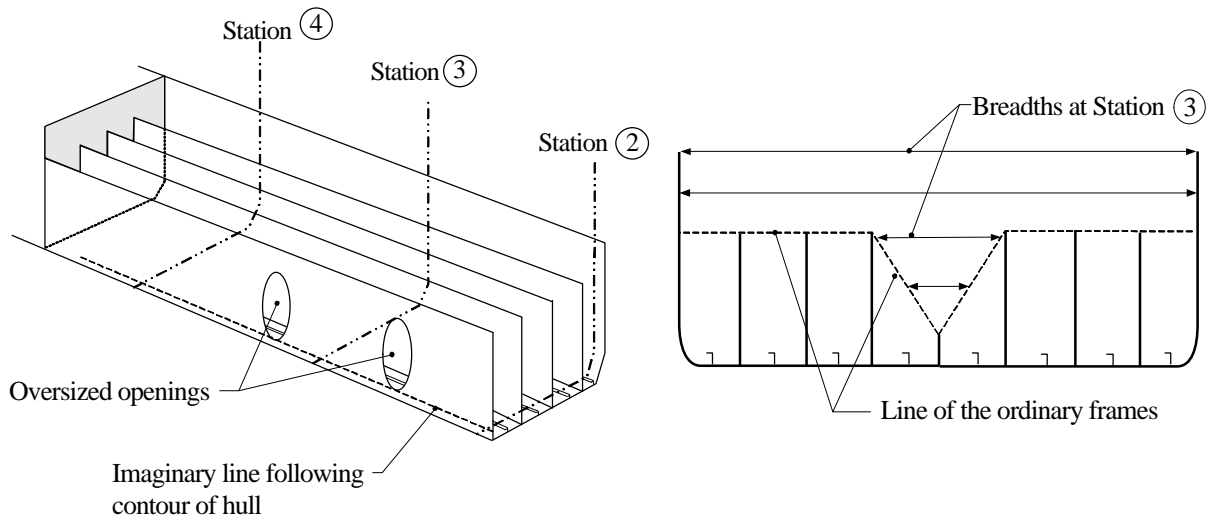

(iv) Longitudinal Framing vs. Bulkheads There is no longer a requirement to place a notch in the upper edge of a longitudinal bulkhead in order to qualify that bulkhead as an ordinary longitudinal frame.

(v) Requirements for Terminating Transverse Frames For the case of longitudinal ordinary frames that end on a transverse frame, the following requirements apply to the terminating transverse frames:

(1) Portions of Frames Above Terminating Frames The portions of those longitudinal frames that are above/inboard of the terminating transverse frames are treated as if they were not there when establishing the line of the ordinary frames.

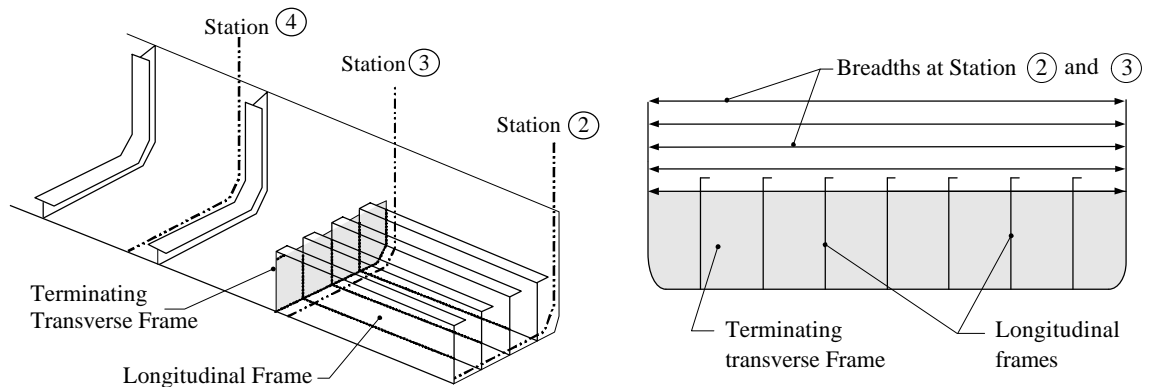

(2) Oversized Openings If an opening in a terminating transverse frame(s) is oversized as defined in §69.109(p)(2)(iii) and overlaps any portion of a longitudinal ordinary frame, the portion of the longitudinal ordinary frame that is above the opening is treated as if it were not there when establishing the line of the ordinary frames. The same treatment applies to a combination of openings whose proximity creates a single oversized effective opening under the criteria of §69.109(p)(2)(iii)(2).

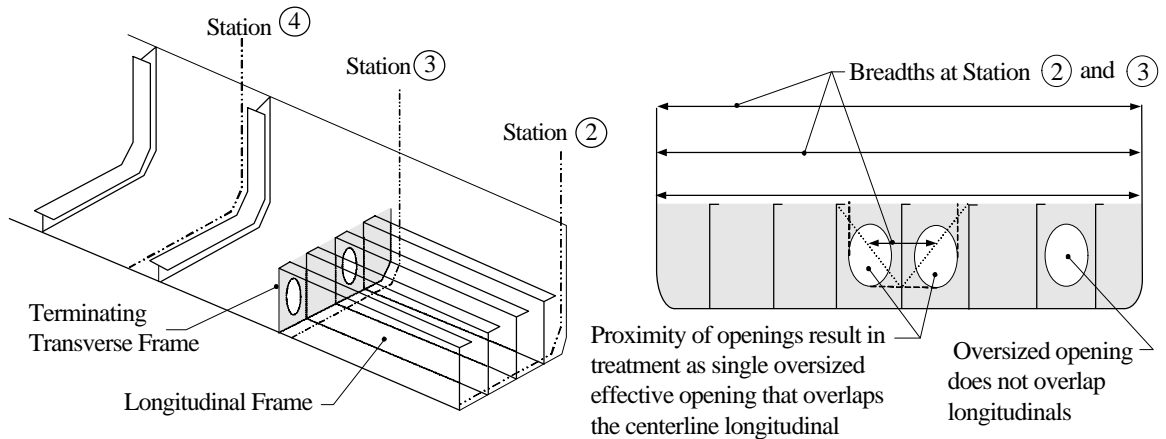

(vi) Transition Between Side and Bottom Frames The following requirement apply:

- (1) Longitudinal Side Frames and Transverse Bottom Frames In order for the lowest frame in a longitudinal side framing sequence to be considered as an ordinary frame, its centerline must be located within 4 feet of the bottom skin of the hull, an ordinary bottom frame or floor used to establish the line of the ordinary frames, or the inner bottom in the case of a double bottom (water ballast). If the lowest frame does not meet this condition, the line of the ordinary frames is established as if all longitudinal side frames were not there.

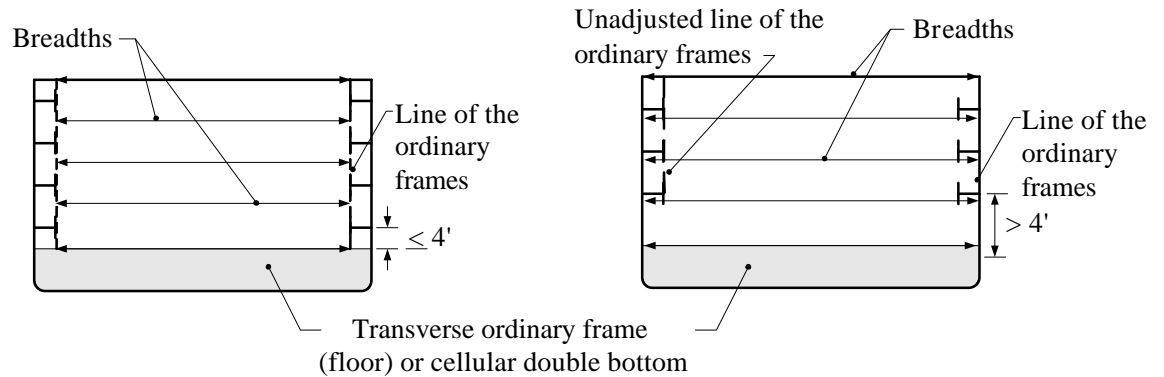

- (2) Transverse Side Frames and Longitudinal Bottom Frames A transverse side frame that continues below the turn of bilge is considered part of a bottom framing system. However, if a longitudinal bottom frame penetrates such a transverse side frame, the line of the ordinary frames is established as if the frame material that is above and inboard of the outboardmost portion of the notch in the transverse frame were not there.

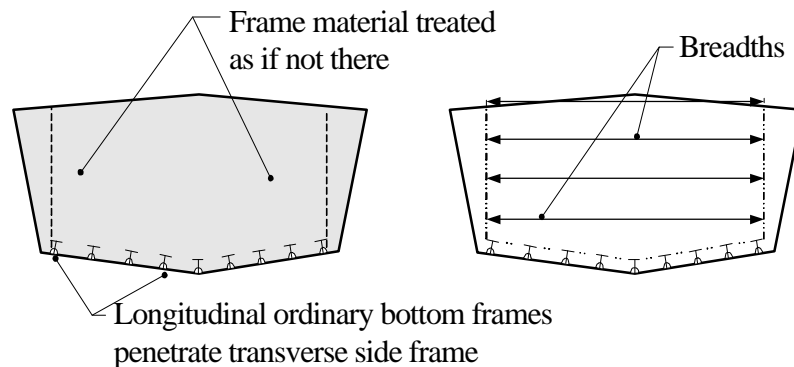

(vii) *Adjustments to the Line of the Ordinary Frames* Except as indicated below, establish the line of the ordinary frames as if the portions of frames that are above and inboard of the outboard most point along the unadjusted line of the ordinary frames were not there. In situations involving tumblehome, the line of the ordinary frames should “follow the hull” above this outboardmost point. Refer to §69.109(q) (6) for treatment of unconventional hull forms. Also, where an ordinary bottom frame (or double bottom (water ballast) tank top) is outboard of the inboard face of an ordinary side frame, the line of the ordinary frames is adjusted so that it runs vertically from the inboard face of the lowest ordinary side frame that is above the line of the ordinary frames down to the line of the ordinary bottom frames (or double bottom (water ballast) tank top).

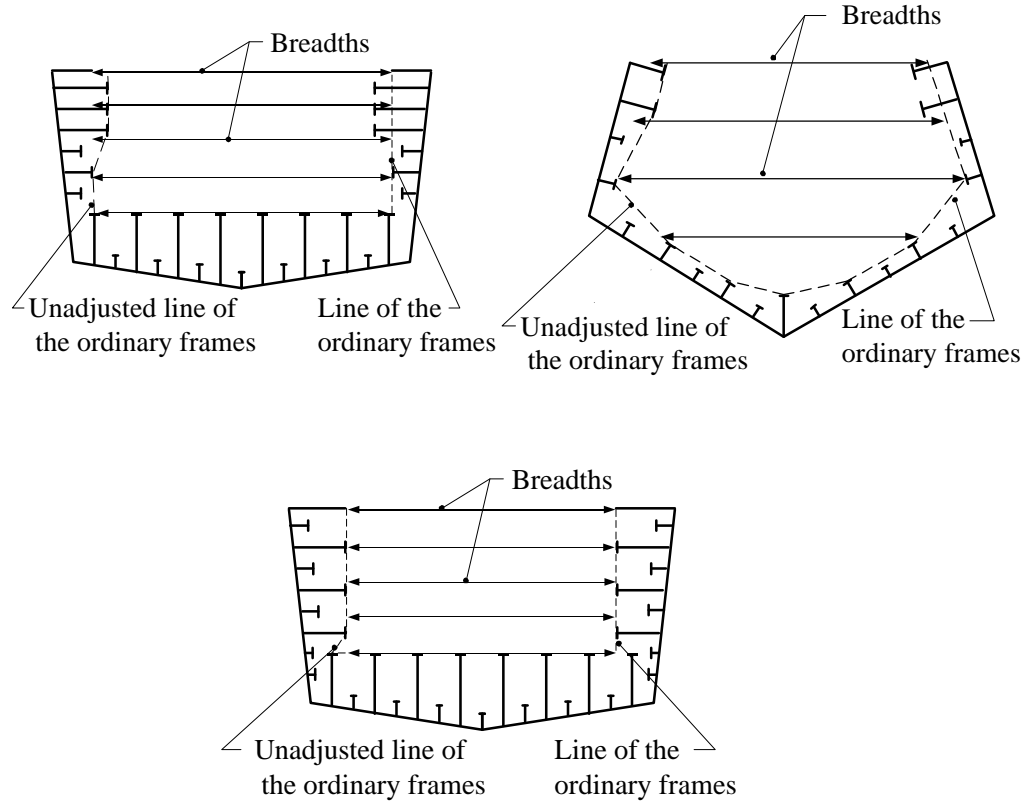

(viii) *Examples* The following examples illustrate the application of the requirements of this section for situations involving longitudinal framing systems with different depths of web. All cases assume: 1) the tonnage section shown is situated in a parallel midbody, where the framing continues without interruption or change for the length of a tonnage interval; 2) the spacing between the bottom and side frames frames is 4 feet or less; 3) the vessel's midpoint depth is 16 feet or less, so there are five breadth measurements and not seven.

Example 1

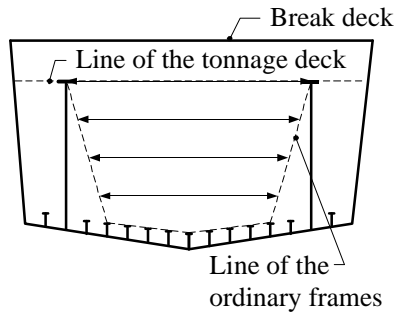

Example 5

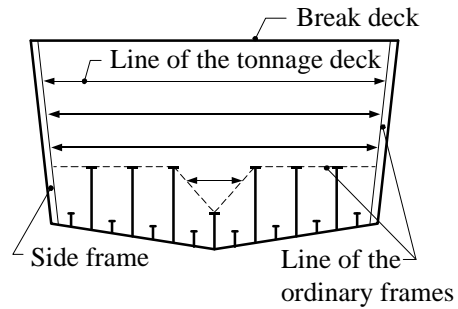

Example 2

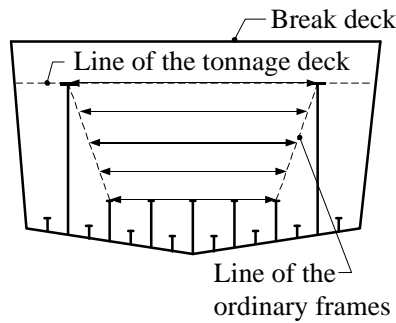

Example 6

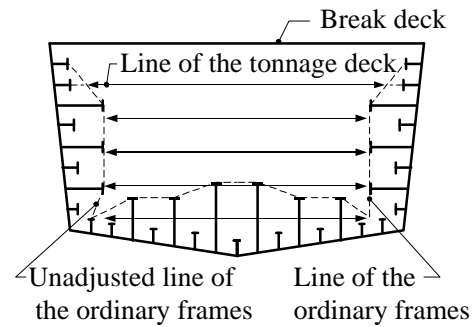

Example 3

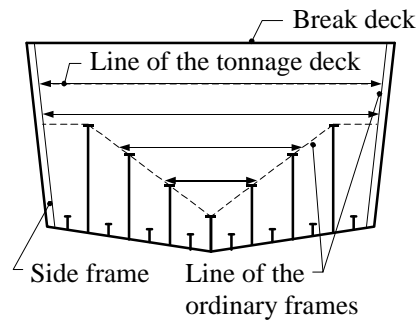

Example 7

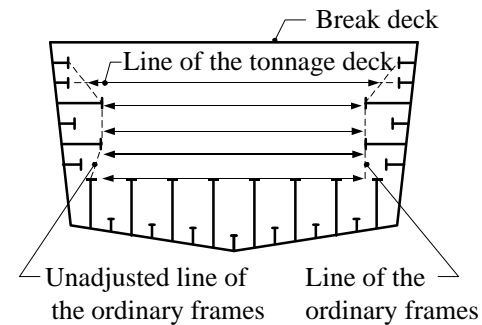

Example 4

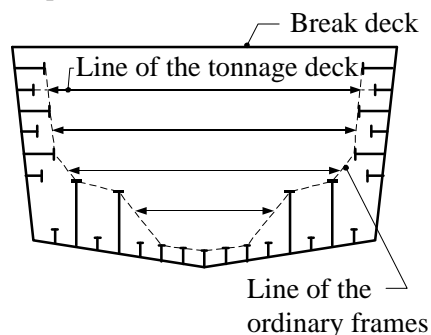

(4) **Bottom Floors and Framing** To qualify as ordinary bottom floors or frames, the frame must be attached to the bottom skin of the vessel inboard of the turn of bilge, and meet all the requirements of ordinary transverse or longitudinal framing. In addition, the following requirements apply:

(i) General The lower terminus of the tonnage depth must coincide with the vertical location where the inboard face of the bottom floors or frames is the lowest. The lowest breadth measurement is taken horizontally at that location.

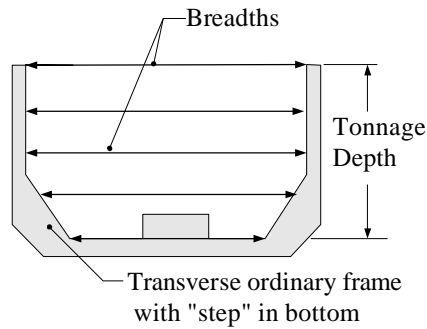

(ii) Longitudinal Floors and Frames In the case of ordinary longitudinal bottom floors or frames, the frames need only run continuously side to side (i.e., turn of bilge to turn of bilge); in other words, the frames need not continue up the sides of the vessel

(iii) Transverse Floors and Frames Ordinary transverse bottom floors or frames must attach to ordinary side frames, if the vessel is fitted with ordinary side frames.

(5) **Asymmetrical Framing** Where ordinary frames are asymmetrical about the centerline of the vessel, breadth measurements are determined by taking half-breadths on the side of the vessel that will yield the greatest area for the respective half of the vessel at that station, and multiplying those half-breadths by a factor of two to yield the full breadths.

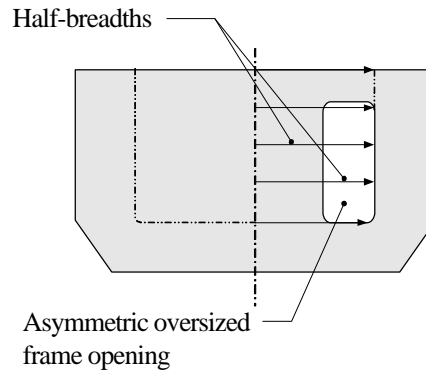
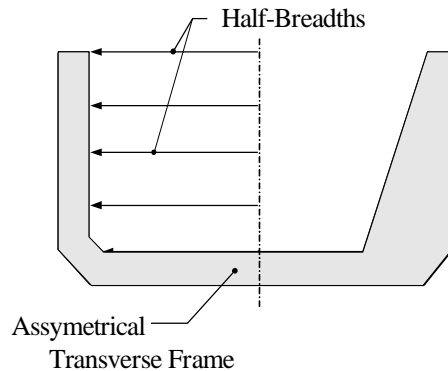



**(q) UNCONVENTIONAL HULL FORMS**

This section provides supplemental requirements to be used in determining the under-deck tonnage in vessels having unconventional hull forms, such as multihull vessels.

- (1) Identifying the Tonnage Deck** Identify the tonnage deck using the criteria provided in §69.109(d). In this context, a watertight bottom skin (or “wet deck”) between hulls that remains above the vessel’s design waterline may be considered as part of the tonnage deck and/or uppermost complete deck.

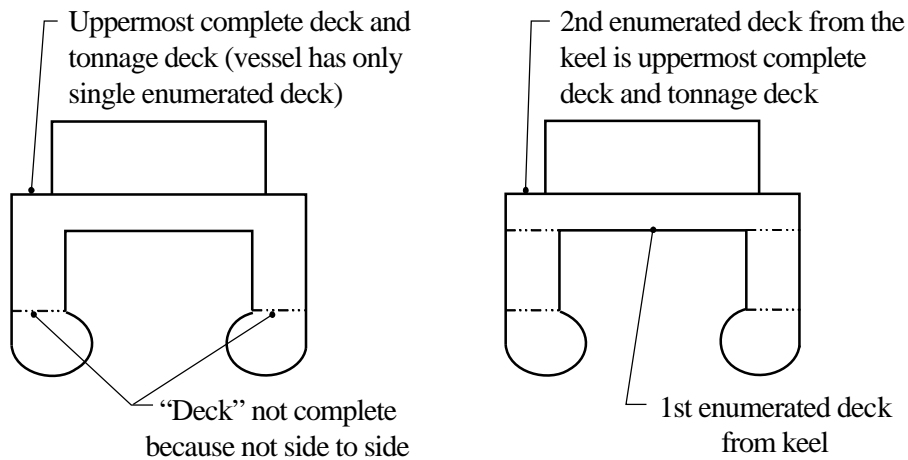

- (2) Establishing Tonnage Length** Refer to §69.109(f). For vessels with complex stem and stern geometries, the tonnage length is the distance between two planes that are perpendicular to the longitudinal axis of the vessel and tangent to the imaginary surface bounding the inboard faces of the ordinary frames at the extreme fore and aft locations of this surface.

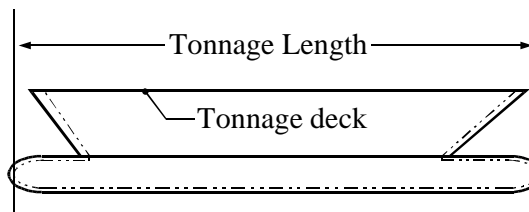

- (3) Establishing Transverse Sections** Once the tonnage length is established, the vessel is divided into transverse sections using the method of §69.109(g).

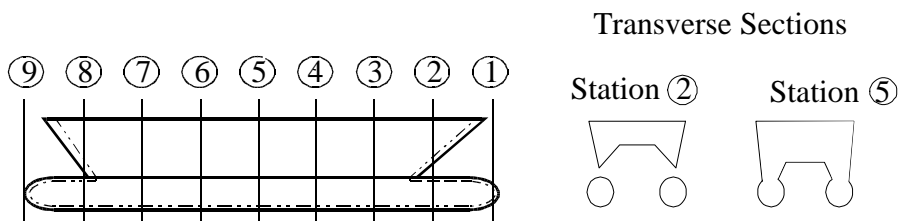

- (4) Identifying Ordinary Frames** These frames are identified in the same manner as for conventional hulls. The same restrictions apply for establishing which are the qualifying ordinary frames as apply to conventional hull forms (refer to the general requirements of §69.109(p)). For example:

- (i) Frames must be spaced on centers that are a maximum of four (4) feet apart across an associated tonnage interval.
- (ii) If there are different sized frames, the largest sized frames that alternate with smaller frames and are spaced on centers that are a maximum of eight (8) feet apart across an associated tonnage interval are used as the basis for establishing the line of the ordinary frames.
- (iii) Frames must be continuous from the bottom of the vessel to the tonnage deck.

If no framing across an associated tonnage interval qualifies, the line of the ordinary frames is taken at the inner surface of the hull shell for the tonnage station of interest.

- (5) **Establishing the Unadjusted Line of the Ordinary Frames** The unadjusted line of the ordinary frames is defined as the line of intersection of: 1) the imaginary surface that is tangent to the inboard faces of the ordinary frames; and 2) the imaginary plane running transversely through the vessel at the tonnage station of interest.

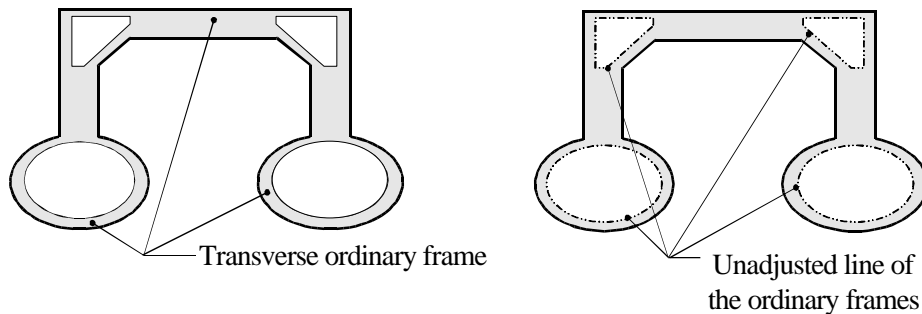

- (6) **Establishing the Line of the Ordinary Frames** The following method is used to establish the line of the ordinary frames at each tonnage station, to which breadth measurements are taken. Note that this process is applied only to the outboardmost portions of the hull.

- (i) Establish Offset Adjustments Establish "offset adjustments" along the outboard sides of the hull(s). "Offset adjustments" are the series of measurements taken between the inner surface of the hull shell and the unadjusted line of the ordinary frames, in a direction perpendicular to the inner surface of the hull shell.

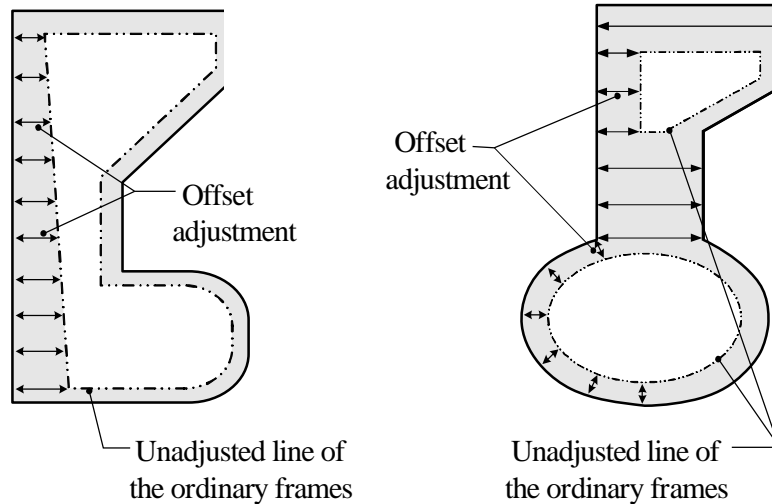

- (ii) Evaluate Each Vertical Location Proceeding from the bottom of the vessel to the line of the tonnage deck, establish the location of the line of the ordinary frames at each vertical location above the bottom of the vessel, as follows:

- (1) Offset Adjustment Length Decreases or Remains Same If the length of the "offset adjustment" is less than or equal to the length of the smallest offset adjustment below the location being evaluated, establish the line of the ordinary frames at the inboard terminus of the offset adjustment.

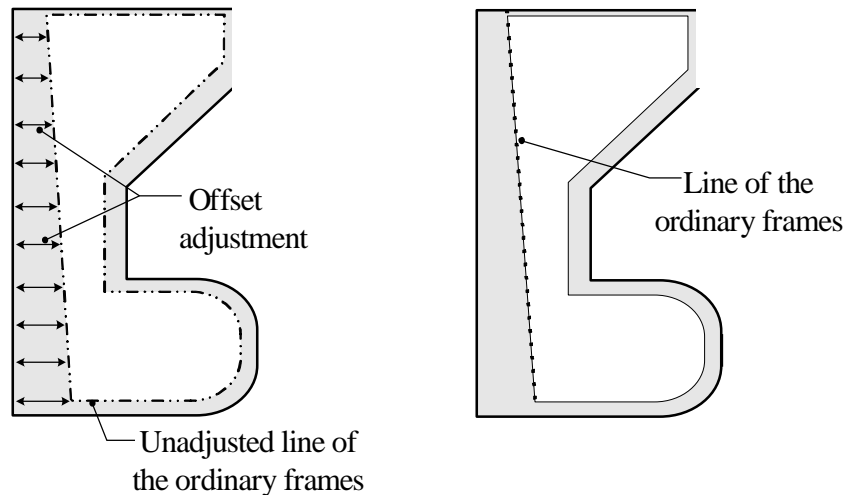

(2) Offset Adjustment Length Increases If the length of the "offset adjustment" is greater than the length of the smallest offset adjustment below, establish the line of the ordinary frames as follows:

(a) Inboard Terminus is Inboard of or Above the Point Below If the inboard terminus of the "offset adjustment" is inboard of or directly above the location of the line of the ordinary frames that is immediately below, establish the line of the ordinary frames using either step (1) or (2) below, whichever yields the smallest sectional area:

(1) Establish the line of the ordinary frames at a distance from the outer terminus of the offset adjustment that is equal to the length of the smallest offset adjustment that is below, as measured "along" the offset adjustment.

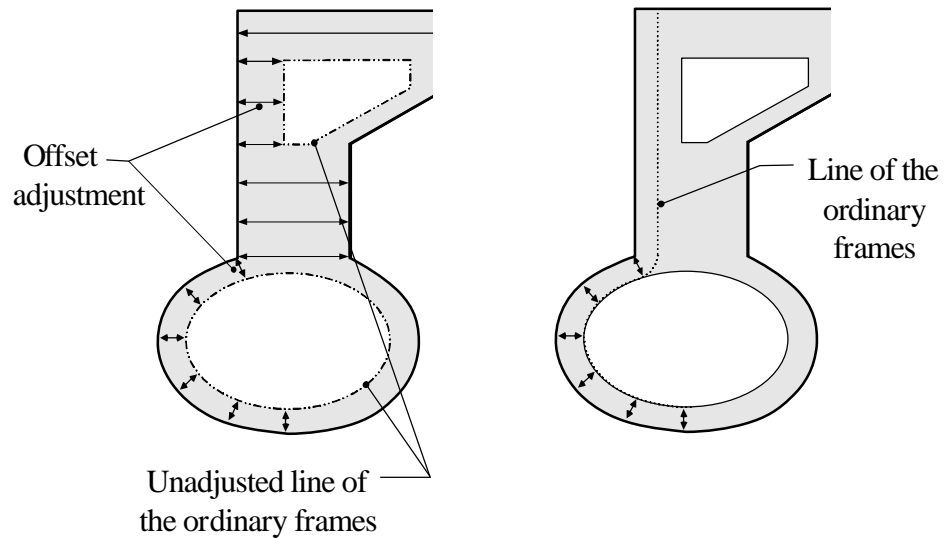

(2) Establish the line of the ordinary frames at the location directly above the location of the line of the ordinary frames for the point that is immediately below.

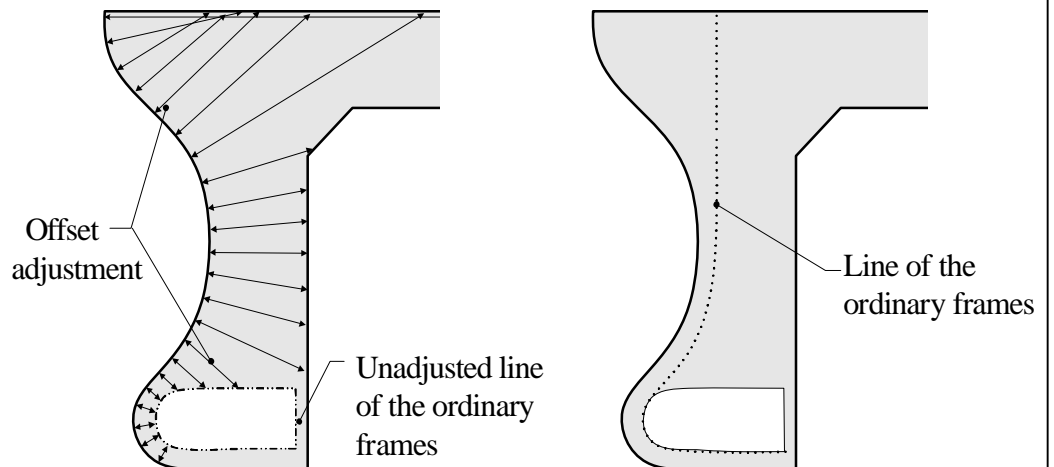

- (b) *Inboard Terminus is Outboard of the Point Below* If the inboard terminus of the "offset adjustment" is outboard of the location of the line of the ordinary frames that is immediately below, establish the line of the ordinary frames at the inboard terminus of the "offset adjustment".

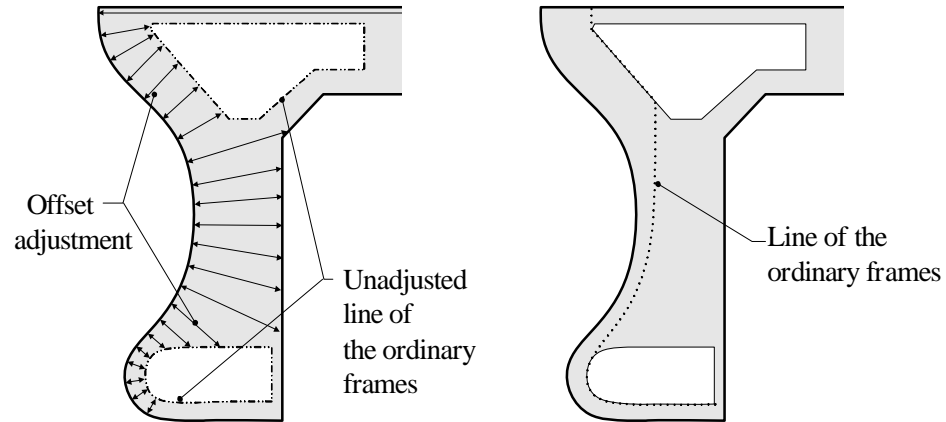

- (7) **Adjusting Breadth Measurements** The breadth measurements are adjusted to account only for the enclosed spaces by subtracting out the portion of the breadth measurement outside the hull boundary.

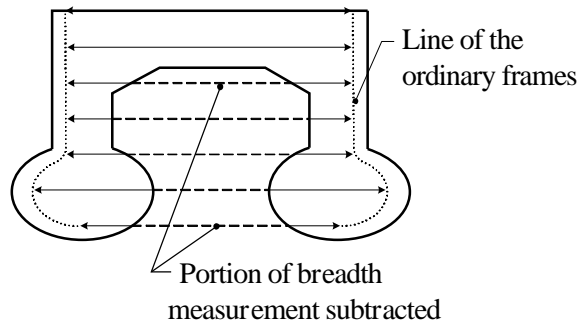

- (8) **Treatment of Wet Deck Area** Breadth measurements may be adjusted using the method of paragraph 7 above to account for that portion of the "cross-deck" or "wet deck" that is open to the sea. If this "wet deck" area is in any way enclosed, it must fully meet the requirements for exclusion as space open to the sea under the convention measurement system in order for the breadth measurements to be adjusted in this manner. Refer to §69.61(f) and (g) for specific requirements (e.g., space cannot be fitted with shelves or other means of securing cargo).

## 69.111 BETWEEN-DECK TONNAGE

This section provides the method for calculating the between-deck tonnage using Simpson's first rule. It also provides procedures for establishing the line of the uppermost complete deck.

### (a) BETWEEN-DECK TONNAGE DEFINED

"Between-deck tonnage" means the tonnage of the space above the line of the tonnage deck and below the line of the uppermost complete deck.

**(b) IDENTIFYING THE LINE OF THE UPPERMOST COMPLETE DECK**

*Establish the line of the uppermost complete deck as indicated below.*

- (1) Deck Runs in Continuous Line** If the uppermost complete deck runs in a continuous line from stem to stern, the line of the uppermost complete deck is the longitudinal line of the underside of the uppermost complete deck.
- (2) Deck Runs at Different Levels** If the uppermost complete deck runs at different levels from stem to stern (*i.e., is stepped longitudinally*), the line of the uppermost complete deck is the longitudinal line of the underside of the lowest portion (*i.e., lowest longitudinal step*) of that deck parallel with the upper portion of that deck. *A longitudinal step being used as the basis for establishing the line of uppermost complete deck must have a length of at least 3 feet in the direction of the vessel's longitudinal axis extending across the full breadth of the vessel at the location of the step. Deck discontinuities that are ignored when establishing which deck is the uppermost complete deck are similarly ignored when establishing the vertical location of the line of the uppermost complete deck. Note: Spaces between the line of the uppermost complete deck and the tonnage deck are included in superstructure tonnage.*

**(c) METHOD OF CALCULATING TONNAGE**

The tonnage of each level of the between-deck space is calculated separately, as follows. *All longitudinal and transverse measurements used to establish between-deck tonnage are terminated at the line of the normal frames.*

- (1) Determine Length** The length of each level is measured at the mid-height between the line of the deck above and the line of the deck below. Measure from the point forward where the continuation of the line of the inboard face of the normal side frames intersects the center line of the vessel aft to the forward face of the normal transom framing.
- (2) Establish Measurement Spacing** Divide the length *determined* under paragraph (c)(1) of this section into the same number of equal parts into which the tonnage length is divided under §69.109(g)(1).
- (3) Measure and Number Breadths** Measure at mid-height between the faces of the normal side frames the inside breadth of the spaces at each end and at each point of division of the length. Number the breadths successively "1", "2", and so forth beginning at the bow.
- (4) Apply Simpson's Multipliers** Multiply the even numbered breadths by four and the odd numbered by two, except the first and last *breadth*, which are multiplied by one.
- (5) Determine Area at Mid-Height** Add together the products under paragraph (c)(4) of this section and multiply the sum by one-third of the interval between the points at which the breadths are taken. The product is the square foot area of the space at mid-height.
- (6) Convert to Tonnage** Multiply the area of the space at mid-height by the average of the heights taken at each point of division of the space. The product divided by 100 is the tonnage of that space.
- (7) Combine the Tonnage of Each Level** The between-deck tonnage is the sum of the tonnage of each level within the between-deck space.

### 69.113 SUPERSTRUCTURE TONNAGE

*This section provides the method for calculating the tonnage of all superstructures.*

(a) **SUPERSTRUCTURE TONNAGE DEFINED**

“Superstructure tonnage” means the tonnage of all permanent structures, such as forecastle, bridge, poop, deckhouse, and break, on or above the line of the uppermost complete deck (or line of shelter deck, if applicable).

(b) **METHOD OF CALCULATING TONNAGE**

*All longitudinal and transverse measurements used to establish superstructure tonnage are terminated at the line of the normal framing. The tonnage of all structures on each level on or above the uppermost complete deck (or shelter deck, if applicable) is calculated separately as follows. This method applies to structures that are not of standard geometric shape, such as a forecastle that is faired into a non-rectangular hull form. Refer to §69.113(f) for the method of calculating the tonnage of standard geometric shapes.*

- (1) **Determine Length** The length of each structure is measured along its centerline at mid-height between the line of the inboard face of the *normal* framing on one end to the line of the inboard face of the *normal* framing on the other end. (See §69.123, figure 11.)
- (2) **Establish Measurement Spacing** Divide the length *determined* under paragraph (b)(1) of this section into an even number of equal parts most nearly equal to those into which the tonnage length is divided under §69.109.
- (3) **Measure and Number Breadths** Measure at mid-height the inside breadth at each end and at each point of division of the length. Number the breadths successively “1”, “2”, and so forth beginning at the extreme forward end of the structure. If an end of the structure is in the form of a continuous arc or curve, the breadth at that end is one-half the nearest breadth. If an end is in the form of an arc or curve having a decided flat, the breadth at the end is two-thirds of the nearest breadth.
- (4) **Apply Simpson’s Multipliers** Multiply the even numbered breadths by four and the odd numbered by two, except the first and last breadth, which are multiplied by one.
- (5) **Determine Area at Mid-Height** Add together the products under paragraph (b)(4) of this section and multiply the sum by one-third of the interval between the points at which the breadths are taken. The product is the square foot area of the structure at mid-height.
- (6) **Convert to Tonnage** Multiply this area by the average of the heights taken at each point of the division of the structure between its decks or the line of its decks. The product divided by 100 is the tonnage of that structure.

(c) **TREATMENT OF STEPPED DECKS/SIDES**

A structure having steps in its deck or side must be measured in parts. **NOTE: This includes structures that bound wells and notches, as measurement by parts is necessary to insure that the volumes of the associated open spaces are not reflected in the superstructure tonnage.**

(d) **COMPUTING SUPERSTRUCTURE TONNAGE**

The superstructure tonnage is the sum of the tonnages of each level above the line of the uppermost complete deck (or shelter deck, if applicable).

(e) **TREATMENT OF SPACES OPEN TO UNDER-DECK**

When a superstructure is located over a cut-away portion of the tonnage deck, the structure's height is measured from the under side of its overhead deck to the line of the tonnage deck. If the tonnage deck has no camber, allow for camber in the overhead deck.

(f) **METHOD OF CALCULATING TONNAGE (STANDARD SHAPES)**

For structures of a standard geometric shape, a simple geometric formula that yields an accurate volume may be used.

**69.115 EXCESS HATCHWAY TONNAGE**

(a) **APPLICABILITY**

Hatchways that are above the tonnage deck and are either open to the weather or within open structures are measured to determine excess hatchway tonnage. Hatchways that are in between-deck spaces, on decks within closed-in structures, or on open structures are not measured.

(b) **METHOD OF CALCULATING TONNAGE**

The tonnage of a hatchway is its length times breadth times mean depth divided by 100. Mean depth is measured from the under side of the hatch cover to the top of the deck beam.

(c) **DETERMINING EXCESS HATCHWAY TONNAGE**

From the sum of the tonnage of the hatchways under this section, subtract one-half of one percent of the vessel's gross tonnage exclusive of the hatchway tonnage. The remainder is added as excess hatchway tonnage in calculating gross tonnage.

**69.117 SPACES EXEMPT FROM INCLUSION IN GROSS TONNAGE**

(a) **PURPOSE**

This section lists spaces which are exempt from inclusion in gross tonnage.

(b) **SPACES ON OR ABOVE THE LINE OF THE UPPERMOST COMPLETE DECK**

The following spaces or portions of spaces on or above the line of the uppermost complete deck are exempt *from inclusion in gross tonnage* if the spaces or portions are reasonable in extent and adapted and used exclusively for the purpose indicated:

(1) **Anchor Gear** Spaces for anchor gear, including capstan, windlass, and chain locker, are exempt.

(2) **Companions** Companions and booby-hatches protecting stairways or ladderways leading to spaces below are exempt, whether or not the spaces below are exempt.

(3) **Galley** Galley or other spaces fitted with a range or oven for cooking food to be consumed onboard the vessel are exempt.

(4) **Light or Air** Spaces designed to provide light or air to propelling machinery are exempt, as follows:

- (i) When propelling machinery is located entirely on or above the line of the uppermost complete deck, the entire propelling machinery space and all fuel bunker spaces that are also located above that line are exempt as light or air spaces. (See exceptions in §69.121(d)(1) for framed-in spaces.)



- (ii) When part of the propelling machinery projects above the line of the uppermost complete deck into a space used exclusively to provide light or air to the propelling machinery, the entire space is exempt as light or air space. When any portion of this space is used for purposes other than providing light or air, only the portion of the space used for light or air, the space occupied by the propelling machinery itself, and a propelling machinery working space allowance under §69.121 limited to two feet, if available, on each side of the propelling machinery are exempt.
- (iii) Any part of an escape shaft, or a companion sheltering an escape shaft, above the line of the uppermost complete deck is exempt as light or air space.
- (iv) Space that would otherwise be exempt as a light or air space is not exempt when propelling machinery is boxed-in and does not extend above the line of the uppermost complete deck. Any portion of the boxed-in space above the line of the uppermost complete deck is exempt.
- (5) **Skylights** Skylights affording light or air to a space below, other than to propelling machinery spaces. Space immediately below the line of the deck on which a skylight is located is exempt only when there is an opening in the next lower deck directly below the skylight to permit light or air to an even lower deck.
- (6) **Machinery Spaces** Machinery spaces, other than for propelling machinery under §69.121.
- (7) **Steering Gear** Spaces for steering gear.
- (8) **Water Closets** Water closet spaces that are fitted with at least a toilet and are intended for use by more than one person. *In this context, “use by more than one person” means “use by more than one specific individual”, rather than “use by more than one person simultaneously”, thereby permitting a water closet in a multiple occupancy passenger cabin to be exempted as water closet space. Areas within a water closet space that are occupied by showers and sinks may be exempted as part of the associated water closet space.*
- (9) **Wheelhouse** The space in a wheelhouse necessary for controlling the vessel.

(c) **PASSENGER SPACES**

- (1) **Passengers on Military Vessels** As used in this section, the term “passenger” includes officers and enlisted men on military vessels who are not assigned ship’s duties and not entered on the ship’s articles.
- (2) **Definition of Passenger Space** As used in this section, “passenger space” means a space reserved exclusively for the use of passengers and includes, but is not limited to, berthing areas, staterooms, bathrooms, toilets, libraries, writing rooms, lounges, dining rooms, saloons, smoking rooms, and recreational rooms. The space need not be part of or adjacent to a berthing area to be considered a passenger space. *Spaces used by both passengers and crew members (e.g., first aid stations), or used for passenger support but not accessible to passengers at all times (e.g., vaults on a gaming vessel) cannot be exempted as passenger space.*

- (3) **Restrictions on Location** A passenger space located on or above the first deck above the uppermost complete deck is exempt from gross tonnage. A deck must be at least six inches above the uppermost complete deck at all points along its length in order for the space to be exempted as passenger space. Also, space that is directly on the uppermost complete deck cannot be exempted as passenger space, even if it is above the line of the uppermost complete deck (as is the case of passenger space on a break deck).

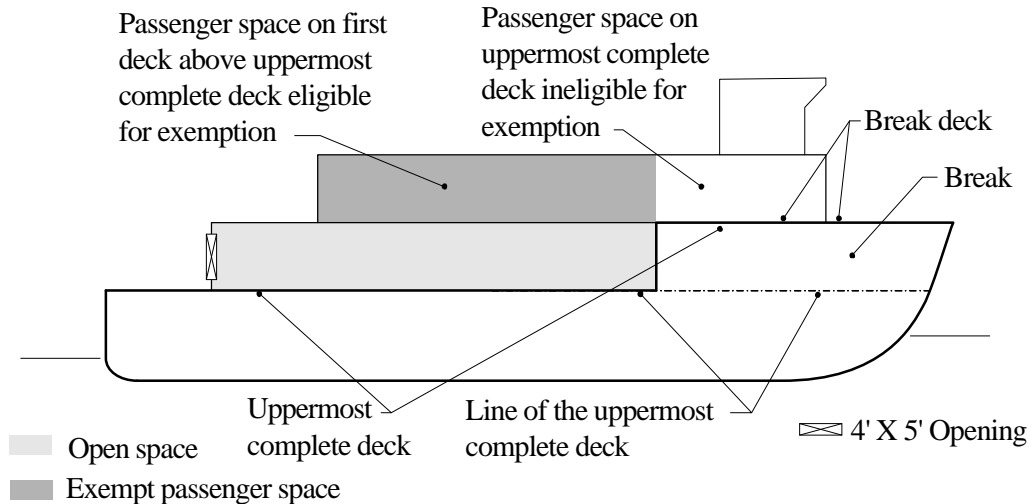

- (4) **Exemption as Open Space** ~~A passenger space located on the uppermost complete deck is exempt from gross tonnage only when it has no berthing accommodations and is an open structure under paragraph (d) of this section. The prohibition against exempting a passenger berthing space as open space is in error, as it conflicts with language contained in the underlying statute and is inconsistent with the principles of "open structures" as set forth in the regulations. Removal of this prohibition from the regulations will be addressed in a future rulemaking.~~

**(d) OPEN STRUCTURES**

**(1) General** Structures that are located on or above the line of the uppermost complete deck that are under cover (sheltered), but open to the weather are exempt from gross tonnage. *The following additional requirements apply:*

(i) Structure Divided Into Compartments If a structure is divided into compartments, only those compartments which are open to weather as provided for in §69.117(d)(2),(2'),(3),(7) and (8) are exempt from gross tonnage under the provisions of this section.

(ii) Progression of Open Space Between and Within Structures Open space cannot progress from one structure into another structure (e.g., from a sunken forecastle to a break aft of the forecastle), nor can it progress vertically through openings in a deck within the structure.

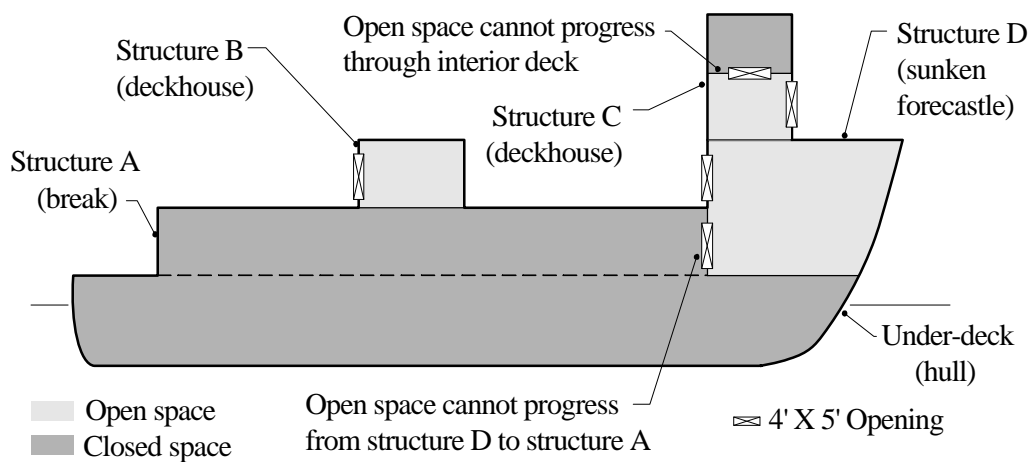

(iii) Treatment of Spaces Outside of Boundary Bulkheads A space that is outside a structure's boundary bulkhead (as defined in §69.53) is considered open to the weather provided either of the following conditions is met:

(1) Excluded Space The space is eligible to be treated as an excluded space under the provisions of §69.61, regardless of whether or not the space is fitted with means designed for securing cargo or stores. Refer to §69.117(d)(3)(ii)(7) for restrictions on progression of open space from such an excluded space.

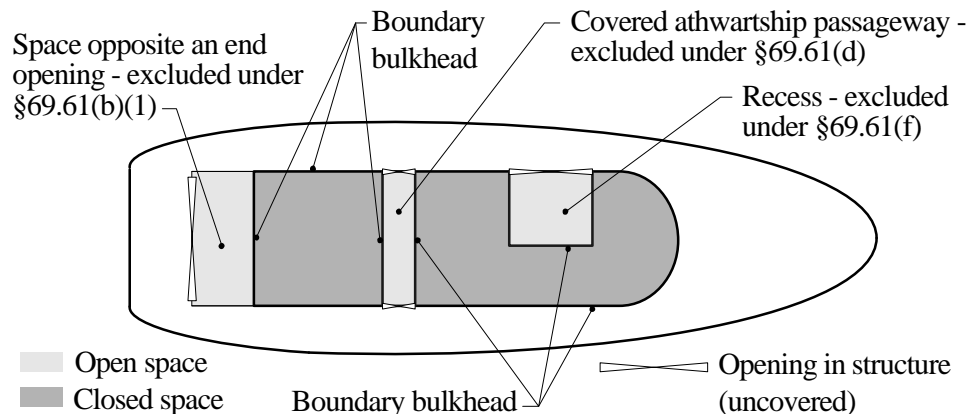

(2) *Space Fitted With End or Side Openings* The space has end or side openings meeting the requirements of §69.117(d)(2) or §69.117(d)(8).

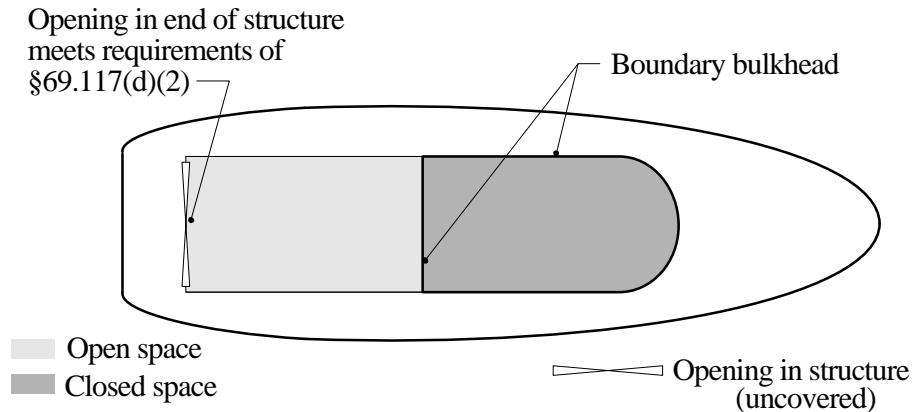

(2) **End Openings** A structure is considered "open to the weather" under paragraph (d)(1) of this section when an exterior end bulkhead of the structure is open and, except as provided in paragraphs (d)(4), (d)(5), and (d)(6) of this section, is not fitted with any means of closing. To be considered "open to the weather", the end bulkhead must not have a coaming height of more than two feet in way of any required opening *as measured to the deck outside the opening*, and have one of the following openings or combinations of openings. Except as provided for in §69.117(d)(3), if the structure has more than one compartment, only that portion of a compartment with an exterior opening or openings meeting the requirements of this section and whose deck is no more than two feet above the associated exterior deck at the end opening(s), is considered "open to weather".

(i) **Two 3' X 4' Openings** Two openings, each at least three feet wide and at least four feet high in the clear on each side of the centerline of the structure. If the openings lead to two separate interior compartments, there must be circulation of open space between the two compartments via an opening (or series of openings) in the intermediate bulkhead(s) meeting the minimum requirements of this section for a 3' X 4' opening. If such circulation does not exist, both openings are considered closed.

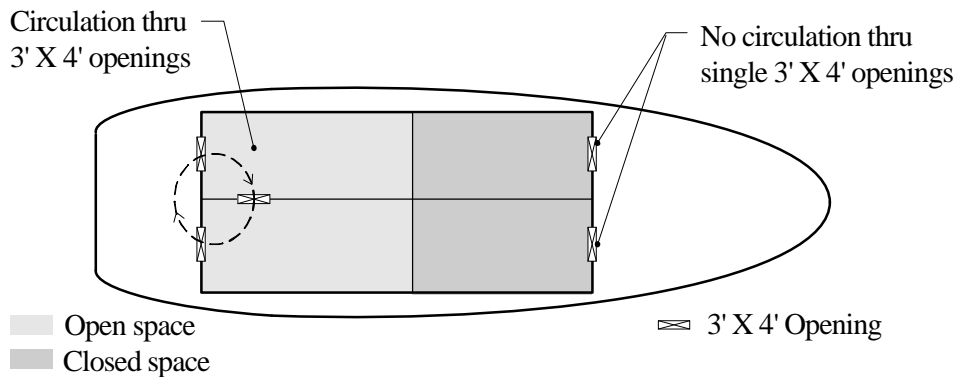

(ii) One 4' X 5' Opening One opening at least four feet wide and at least five feet high in the clear.

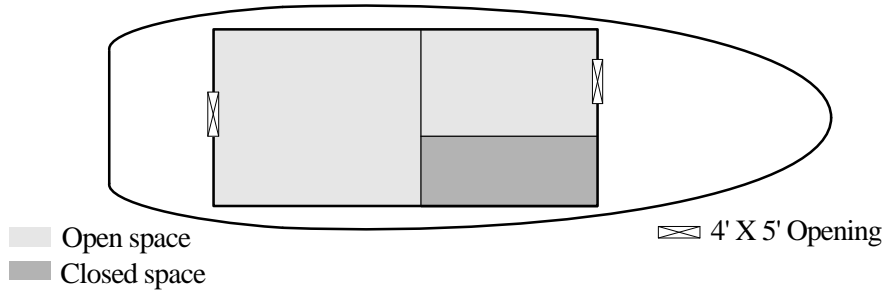

(iii) One Equivalent Opening One opening at least 20 square feet in the clear with a breadth in excess of four feet and a height of not less than three feet.

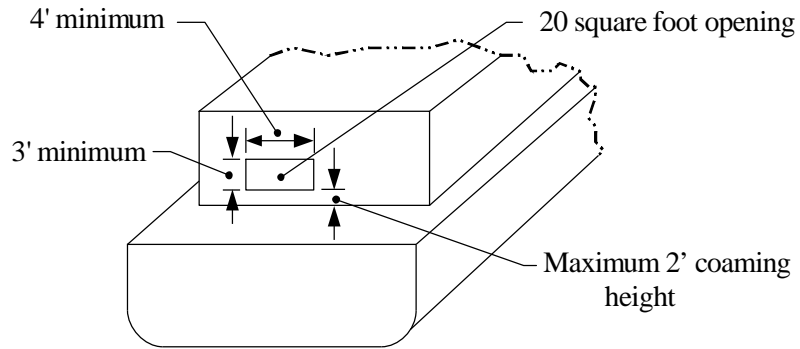

(2') **Additional Requirements for End Openings** In addition to the requirements of §69.117(d)(2), the following requirements apply to end openings:

(i) **In the Clear Requirement** To be considered in the clear as described in §69.117(d)(2), the opening must be unobstructed for a distance of 30 inches both inside and outside of the opening. Obstructions of a temporary nature (i.e., that are not permanently attached to the vessel, can readily be removed underway, and whose removal does not adversely impact the safe operation of the vessel) are not considered to violate the in the clear requirement. For example, portable furniture and lockers are considered to be of a temporary nature, whereas bulkheads, stanchions, bunks that are part of joiner work, and handrails are not. In all cases, attachments to temporary covers authorized under §69.117(d)(6') and deck cargo are not considered to violate the in the clear requirement.

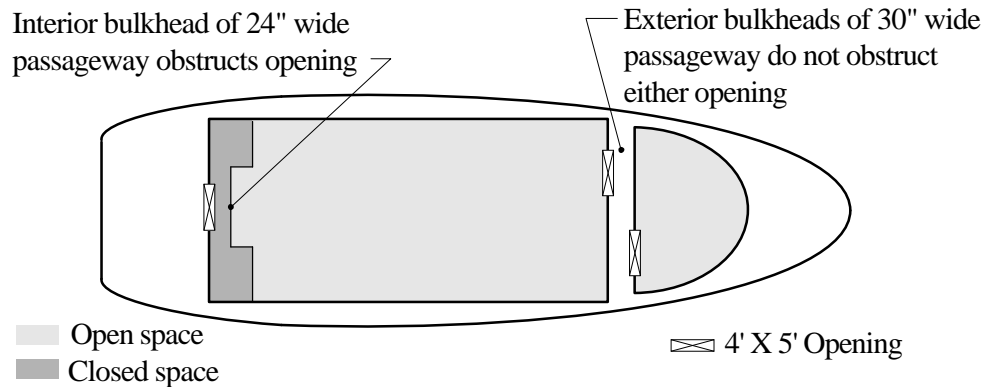

(ii) **Minimum Opening Dimensions** Minimum opening dimensions must be maintained throughout the entire width and height of the opening. For example, coamings, shifting board channel sections, and rounded corners must not infringe on minimum width and height requirements of the opening.

(iii) *Progression of Open Space Within the Structure:* Open space is considered to progress from openings meeting the minimum requirements of this section throughout the associated interior compartment. Obstructions within the compartment (e.g., passenger seating, stanchions, false ceilings, handrails and furniture) are not considered to interfere with the progression of open space within the same compartment, whether or not the obstructions are temporary in nature. However, such obstructions installed within 30 inches of an end bulkhead opening could cause the entire compartment to be treated as closed, depending on whether or not the obstruction is temporary in nature as described in §69.117(d)(2')(i).

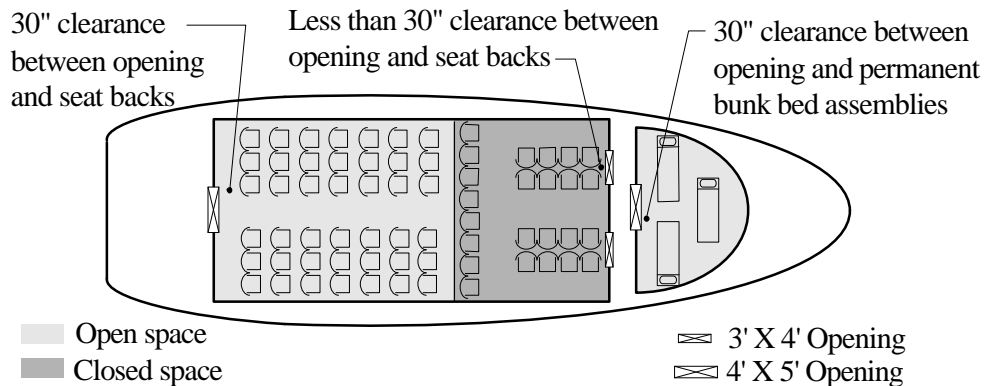

(iv) *Angled or Curved Bulkheads* To qualify as an end bulkhead, the portion of the bulkhead in way of a qualifying opening must not be oriented any greater than 45 degrees from the horizontal or athwartship planes. Width, height and area requirements for openings in angled or curved end bulkheads are applied to the longitudinal projection of the opening onto a vertical athwartship plane at the opening.

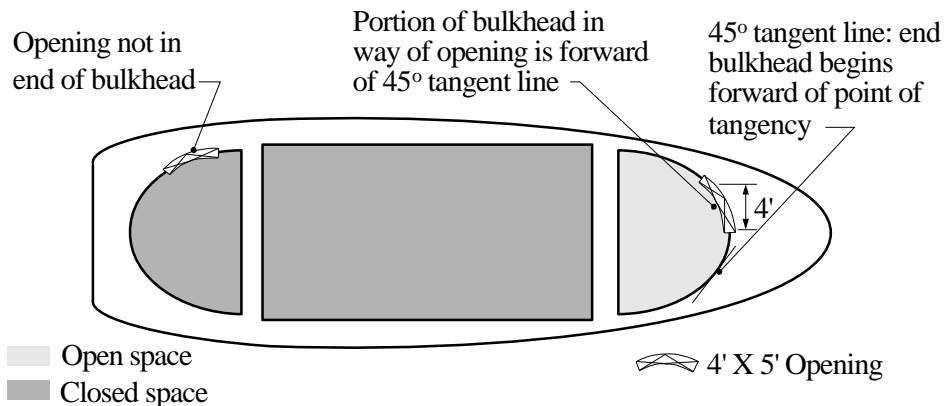

(v) *Deck or Platform on Exterior Side of Opening* There must be a permanent deck or platform that is a minimum of 30 inches wide on the exterior side of the opening. The deck or platform can either be solid or a grating. It must extend at least the full width of the opening, and be no more than 2 feet below the bottom edge of the opening.

(3) **Open Space Progression to Interior Compartments** A compartment within an open structure is considered open to the weather only when an interior bulkhead of that compartment has an opening or openings that meet the requirements for end bulkheads under paragraphs (d)(2)(i) through (d)(2)(iii) of this section, and the deck of that compartment is no more than two feet

above the associated exterior deck at the end opening(s). Other compartments within the structure are not considered open to the weather. The following additional requirements apply:

- (i) Establishing Compartment Boundaries: In this context, a compartment is defined as a space within an open structure that is bounded by bulkheads and the deck above and below. Passageways and dead-ended recesses are considered to be part of the larger compartment to which they are connected, until such point that the passageway and/or dead-ended space increases in height or width, beyond which point the space is considered to be a separate compartment. For situations where one boundary of a compartment is not clearly defined (e.g., a situation involving corners), the "projected" boundary that delineates the compartment is taken as the continuation of the bulkhead of the compartment from which open space is progressing. Also, in those situations where an exterior bulkhead bounding the compartment is absent, the outermost edge of the deck overhead delineates the boundary of the compartment.

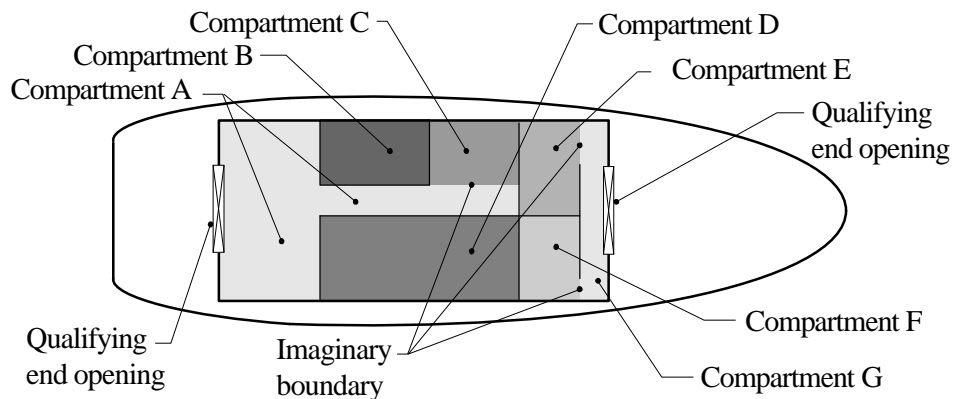

- (ii) Progression of Open Space From Other Interior Compartments: For the interior compartment to be treated as open, the compartment (or series of compartments) from which open space progresses must have opening(s) that meet the requirements for end bulkhead openings under §69.117(d)(2) and (2'). In addition, the following requirements apply:



(1) Opening Location The following requirements apply:

(a) Interior vs. Exterior Openings An interior bulkhead is defined as a bulkhead which is inside of the outer boundary of the structure (i.e., inboard of the outboardmost edge of the deck that covers the structure), and which does not adjoin any portion of a space which is eligible for exclusion under the provisions of §69.61, regardless of whether or not the space is fitted with means designed for securing cargo or stores. An opening not located in an interior bulkhead is treated as an exterior bulkhead opening. Refer to the restrictions of §69.117(d)(7) concerning progression of open space from excluded spaces.

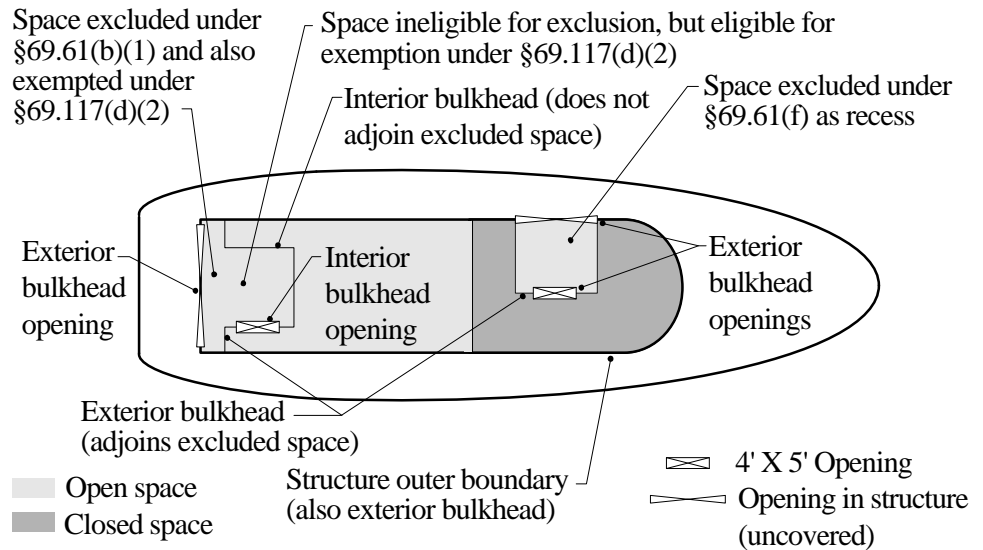

**NOTE:** The distance of an opening from the end of the structure is no longer a factor in evaluating whether an opening is an interior or an exterior opening.

(b) Location on Bulkheads Interior bulkhead openings that otherwise meet the requirements of §69.117(d)(2) may be installed in longitudinal as well as transverse interior bulkheads, and may be located anywhere along the bulkhead.

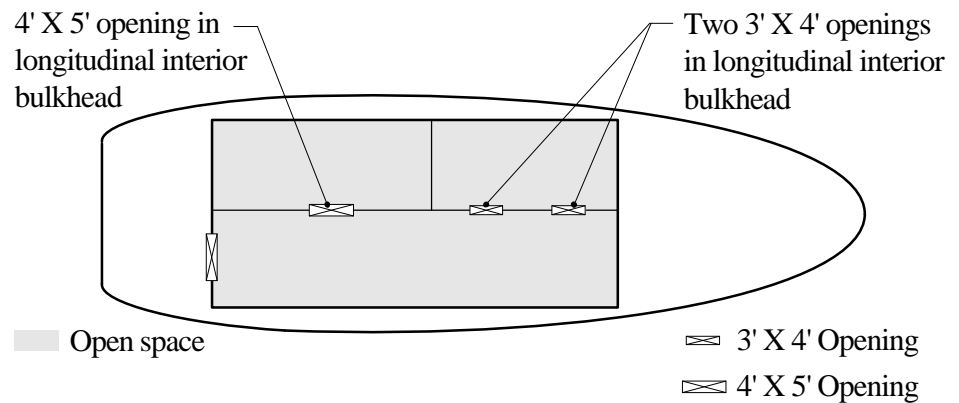

- (2) Circulation Requirement The circulation requirement of §69.117(d)(2)(i) must be met for all interior bulkhead 3' X 4' openings:

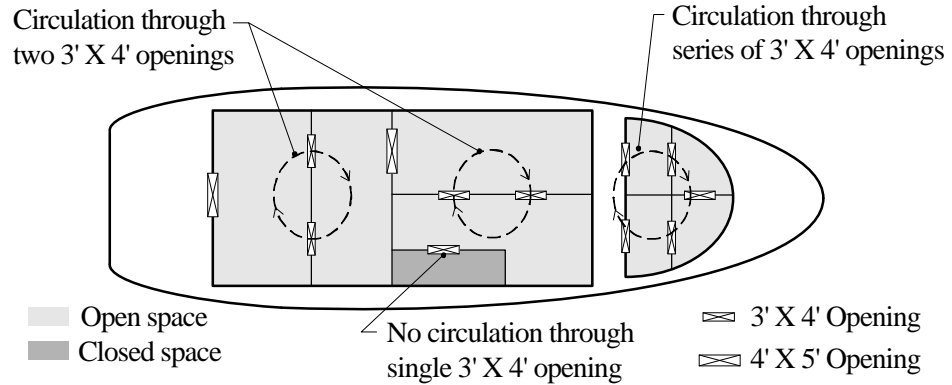

- (3) Obstructions to Interior Bulkhead Openings The in the clear requirement of §69.117(d)(2')(i) must be met for all interior bulkhead openings. As discussed in §69.117(d)(2')(iii), obstructions within a compartment that are not within 30 inches of an opening do not affect progression of open space.

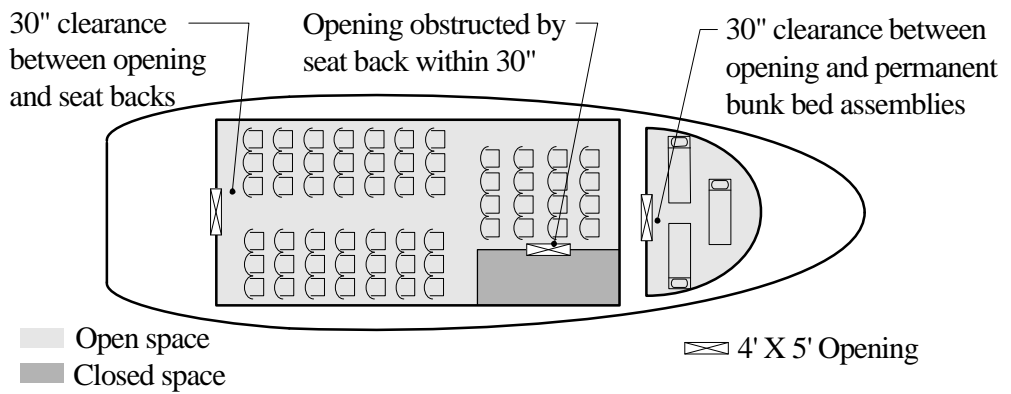

- (4) *Obstructions for Openings Where Boundary Not Clearly Defined* In situations where the boundary of an interior compartment is not clearly defined, the 30 inch in the clear requirement of §69.117(d)(2')(i) is applied to an "opening" in the projected boundary established in §69.117(d)(3)(i).

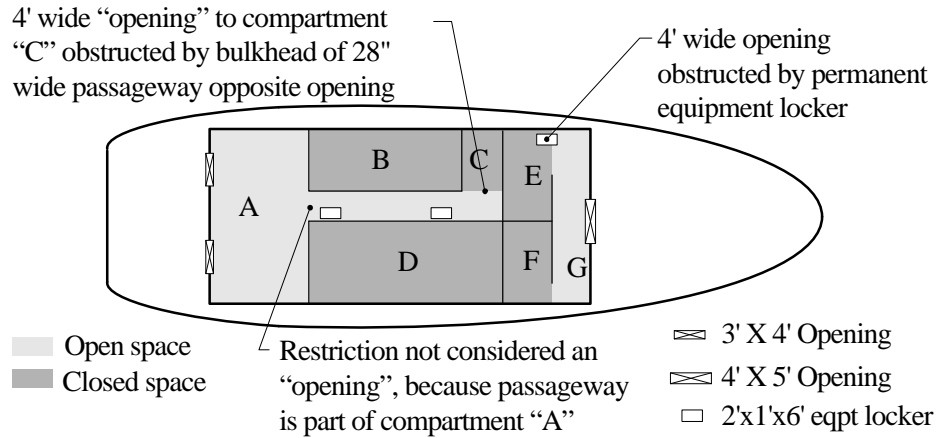

- (5) *Temporary Covers for Openings* In applying the requirements of §69.117(d)(4),(5) and (6) to interior bulkhead openings, the weather side of the bulkhead is considered to be the side toward the associated exterior end bulkhead opening from the direction that the open space is progressing. In the case of 3' X 4' openings used to progress space from two different compartments, the temporary cover can be on either side of the compartment bulkhead.
- (6) *Propelling Machinery Space Bulkheads* There is no longer a prohibition against progression of open space through a propelling machinery space bulkhead.
- (7) *Open Space Progression from Excluded Spaces* Open space cannot progress from a space that is open under the provisions of §69.117(d)(1)(iii)(1) unless the latter space can also be considered open under the provisions of §69.117(d)(2) or (8).

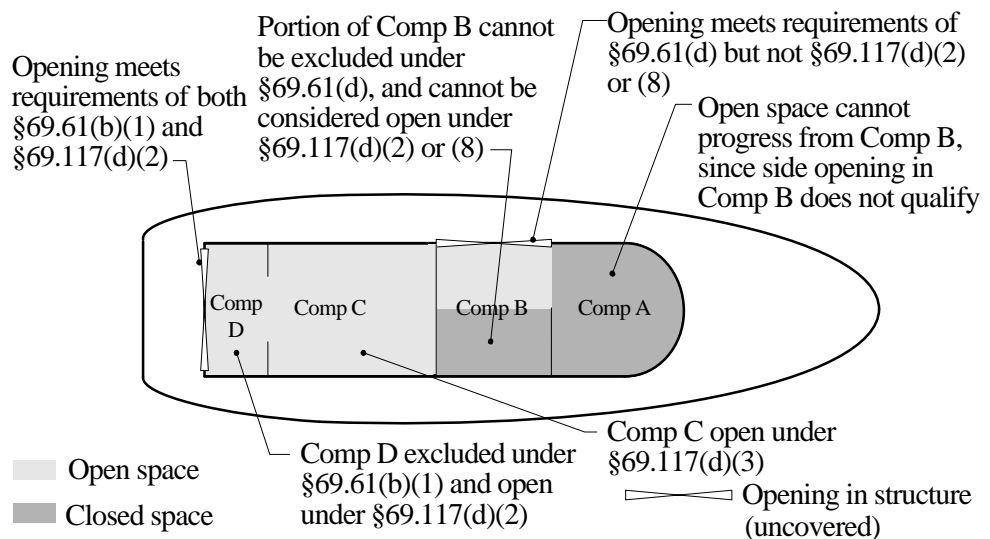

(iii) Treatment of Bars and Similar Subspaces Partitions used to partially bound bars, serving areas, and similar subspaces within a larger compartment are not considered to be a bulkhead that subdivides the associated space into a separate compartment, provided the partition has an opening or openings into the surrounding compartment without means of closure that meet(s) the following criteria:

- (1) Opening height is at least one-third of the height of the larger compartment.
- (2) Bottom of opening is no more than 42 inches above the deck of the larger compartment at the opening.
- (3) Opening is in the clear as described §69.117(d)(2')(i), except for the stanchions (or equivalent) necessary for the support of the deck above.
- (4) For subspaces with only one side open to the larger compartment, the opening must extend the full width or length of the larger compartment. For all other subspaces, at least two sides of the subspace must be open to the larger compartment as described in this section, with each opening extending the full width or length of the respective side.

(4) **Shifting Boards in Channels** An interior or exterior opening that is temporarily closed by shifting boards dropped into channel sections at the sides of the opening is considered open to the weather if battening, caulking, seals, or gaskets of any material are not used.

(5) **Plates/Boards With Hook Bolts** An interior or exterior opening that is temporarily closed by cover plates or boards held in place only by hook bolts is considered open to the weather –

- (i) Hook Bolts If hook bolts, “J” bolts, or “L” bolts used to secure cover plates or boards are spaced at least one foot apart and hook over a stiffener installed around the perimeter of the opening;
- (ii) Faying If the cover plates or boards fit tightly against the *weather side of the* bulkhead; and
- (iii) Sealing If battening, caulking, seals or gaskets of any material are not used.

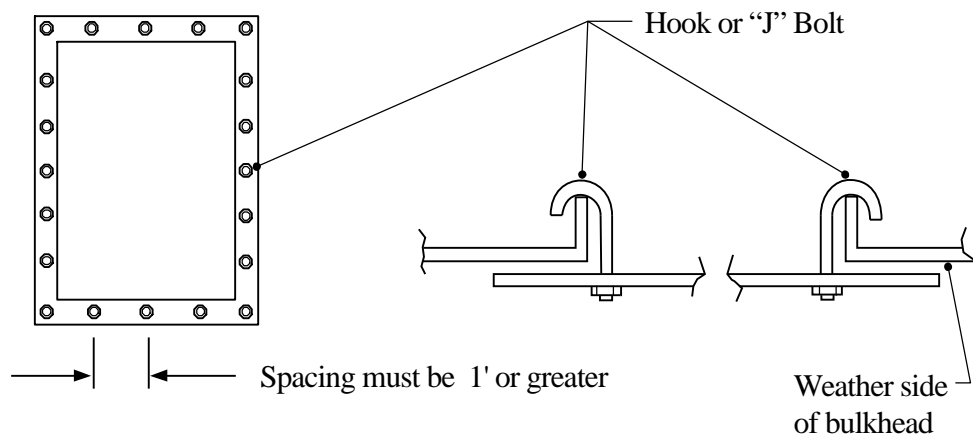

(6) **Plates/Boards With Bolts and Crosspieces** An interior or exterior opening that is temporarily closed by cover plates or boards held in place only by bolts and crosspieces (*i.e.*, “strongbacks”) is considered open to the weather –

- (i) Bolts If the bolts are not installed through the bulkhead. *There are no requirements on bolt spacing;*
- (ii) Securing Devices If the bolts and crosspieces are not held in place by cleats or other attachments to or through the bulkhead;
- (iii) Faying If the cover plates or boards fit tightly against the *weather side of the* bulkhead; and
- (iv) Sealing If battening, caulking, *seals* or gaskets of any material are not used.
- (v) Plates as Crosspieces *There is nothing to preclude the use of a single backing plate or board covering the inside of the opening as a crosspiece (a so-called "sandwich" construction).*

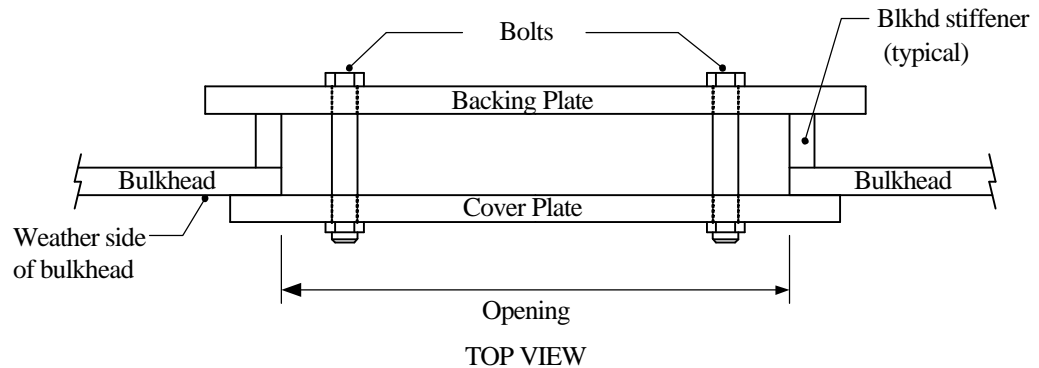

**(6') Additional Requirements for Temporary Covers** *The following additional requirements apply to temporary covers described in §69.117(d)(4),(5) and (6):*

- (i) Cover Boards and Plates *Each plate or board may be composed of more than one element, which may be of different materials, though the individual elements of each plate or board must be permanently bonded together to form an integral unit. For example, trim strips on the outer edges of a cover plate must be permanently bonded to the plate in order to be considered a continuation of that plate.*
- (ii) Attachments and Penetrations *Anything affixed to, or installed in, a temporary cover (e.g., paneling or bulkhead "plugs" attached to cover plates, insulation, doors, windows, fans, air conditioners, and fire hoses) must not: 1) be affixed to the adjoining bulkhead; 2) in any way hinder the removal of the cover; or 3) overlap the edges of the opening in any manner so as to make the cover more than non-tight. For example, a solid piece of insulation overlapping the edges of a cover plate would render the opening closed, whereas electrical equipment mounted on a cover plate but plugged into a wall receptacle on the bulkhead would not.*

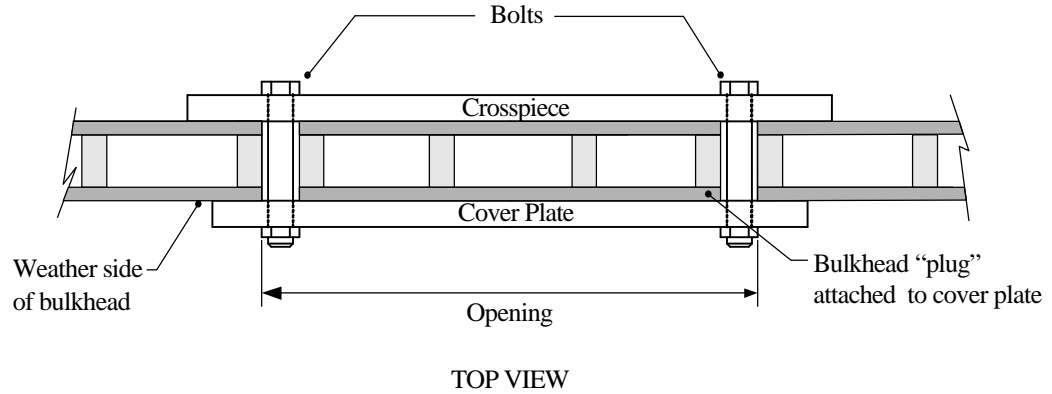

- (iii) Cover Fasteners Fasteners used to hold cover plate(s) or board(s) in place must be designed such that removal of the fasteners causes the associated plates(s) or board(s) to "fall free". The fasteners must be completely accessible to the extent that the plate can be readily removable at all times; otherwise, the associated opening is considered closed. Anything used to "hide" the portions of the fasteners to which access is required must be of a temporary nature as described in §69.117(d)(2')(i), and must be attached only to the cover plate(s), board(s) or crosspiece(s).
- (iv) Reserved
- (v) Alternate Covers In addition to the temporary covers described in §69.117(d)(4),(5) and (6), wire mesh or a flexible fabric-like material (such as canvas) may be applied to an otherwise uncovered opening without closing the opening. Framing, cleats, battens or cross braces, if used to secure the wire mesh or fabric, must not interfere with the in the clear requirement for the opening as described in §69.117(d)(2')(i). **NOTE: No other alternate covers are authorized. This includes sliding doors, hinged doors, and expandable partitions installed across otherwise qualifying openings, even if the item clears the opening when in the open position and/or can be easily removed.**
- (vi) Impact on Vessel Safety As is the case with other tonnage reduction features, it is the responsibility of the designer/owner/operator to ensure that safety aspects of temporary covers are carefully evaluated. For example, an opening cannot be made to be watertight using temporary covers described in §69.117(d)(4),(5) or (6) and, therefore, could compromise a vessel's watertight integrity. For fire protection of temporary covers, refer to the requirements of Navigation and Vessel Inspection Circular (NVIC) 9-97, Guide to Structural Fire Protection.
- (7) **Structures Entirely Open From Aft End** Notwithstanding the opening size requirements of §69.117(d)(2), a structure with its aft end entirely open from the under side of its overhead stiffeners down to the deck, to the line of the deck, or to a coaming not exceeding three inches in height and open athwartships between the inboard faces of the side stiffeners is considered open to weather. The opening may be covered by a wire mesh screen or temporarily closed by a flexible fabric-like material (such as canvas) secured at the top and lashed or buttoned in place. Open space may progress from a compartment open from the aft end to another compartment, provided the requirements of §69.117(d)(3) for progression of open space within a structure are met.

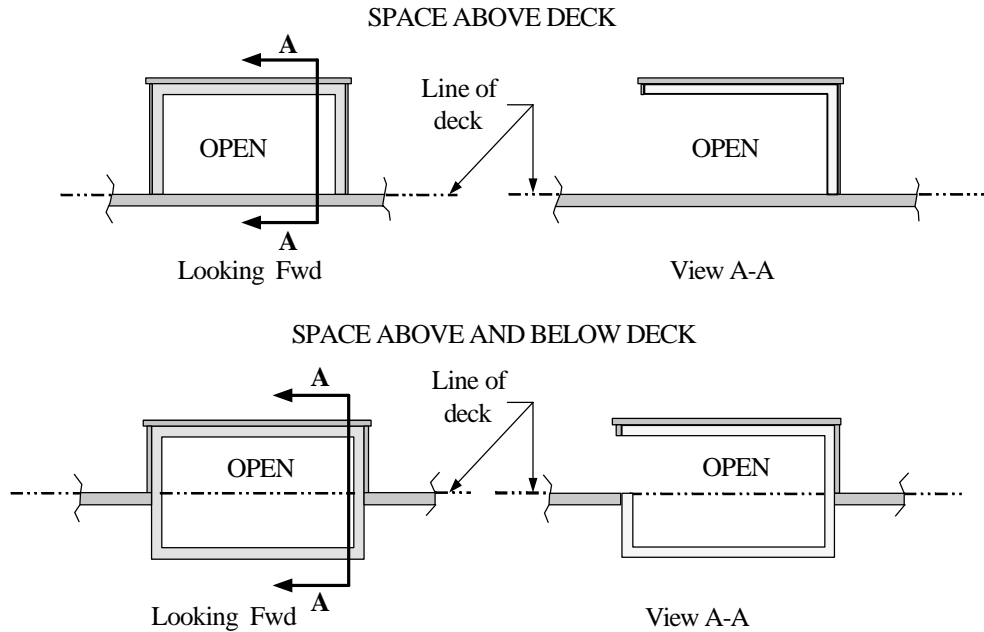

(8) **Opposite Side Openings** A structure is considered "open to the weather" under §69.117(d)(1) if both sides of the structure are open and, except as provided for in §69.117(d)(4),(5) and (6), are not fitted with any means of closing. The following additional requirements apply:

(i) Openings are Opposite and Not Separated by Bulkheads The openings must be directly across from each other, on opposite sides of the structure, and must not be separated by a bulkhead (or bulkheads).

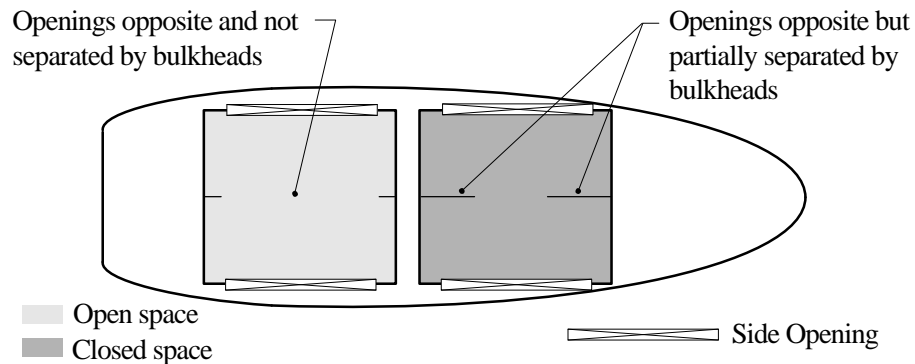

(ii) Additional Opening Requirements Each opposite side opening or combination of openings must be in the clear as defined in §69.117(d)(2')(i) and meet the minimum area requirements that follow. When a combination of openings on each side are used to meet minimum area requirements, the openings cannot be separated from the adjacent opening(s) by any more than the stanchions (or equivalent) necessary to support the overhead deck covering. Where a 3 foot minimum height is specified, the minimum height must be maintained throughout the entire length of the opening (e.g., the height cannot be infringed on by rounded corners).

- (1) 60 Square Feet and 3 Feet High The opening(s) on each side must have an aggregate area of least 60 square feet and a continuous height of at least 3 feet.
- (2) 60 Square Feet and Full Height The opening(s) on each side must have an aggregate area of least 60 square feet and must extend the full height of the sides.
- (3) Full Length of Structure and 3 Feet High/Full Height The opening(s) on each side must: 1) extend the full length of the sides of the structure; and 2) have a continuous height of at least 3 feet or the full height of the structure, whichever is less.

(iii) Coamings There are no restrictions on coaming heights (if fitted) beneath the openings.

(iv) Progression of Open Space Open space will progress from a compartment open to the weather using opposite side openings to another compartment, provided the requirements of §69.117(d)(3) for progression of open space within a structure are met.

**(e) OPEN SPACE BETWEEN THE SHELTER DECK AND THE NEXT LOWER DECK**

- (1) **General** Space that is between the shelter deck and the next lower deck (*by definition, the uppermost complete deck*) and that is under cover (sheltered) but open to the weather is exempt from gross tonnage when all openings in the uppermost complete deck are provided with a watertight means of closing. *Associated scuppers cannot be submerged under any loading condition if open space is to be exempt from gross tonnage under this section.*
- (2) **Requirements for Middle Line Openings** A space is considered “open to the weather” under paragraph (e)(1) of this section when the shelter deck above the space has a middle line opening which conforms to the following:
  - (i) **Size and Shape** The middle line opening must be at least four feet long in the clear and at least as wide as the after cargo hatch on the shelter deck, but not less than one-half the width of the vessel at the midpoint of the length of the opening. The opening may have rounded corners not exceeding a nine inch radius. When a greater radius is required by the Coast Guard or a Coast Guard recognized classification society under §42.05-60 of this chapter, notification of that requirement must be submitted to the Commandant (*Marine Safety Center*).
  - (ii) **Longitudinal Position** The middle line opening must be located so that the distance between the aft edge of the middle line opening and the vessel’s stern is not less than one-twentieth of the tonnage length of the vessel and the distance between the fore edge of the opening and the vessel’s stem is not less than one-fifth of the tonnage length of the vessel.
  - (iii) **Enclosing Structures** The middle line opening must not be within a structure of any type.
  - (iv) **Railings and Stanchions** If the middle line opening is guarded by rails or stanchions, the rails and stanchions must not be used to secure or assist in securing a cover over the opening.
  - (v) **Coamings and Covers** The coaming of the middle line opening must not exceed one foot mean height above the shelter deck. Bolts must not pass through the stiffeners or flanges on the coaming, nor may there be any other attachments on the coaming for fastening a cover.



Portable wooden covers may be fitted over the middle line opening if held in place only by lashings fitted to the under side of the covers. Metal covers may be fitted if held in place only by hook bolts spaced not less than 18 inches apart that pass through the cover and hook over angle stiffeners or flanges fitted to the outside of the coaming. *Battening, caulking, seals or gaskets of any material may not be used in association with any middle line opening cover.*

- (vi) **Space Below Opening** The space below the middle line opening must have a minimum length of four feet throughout its entire breadth and height and be in the clear at all times.
- (vii) **Scupper Requirements** A scupper having a five inch minimum inside diameter and fitted with a screw down non-return valve geared to and operated from the shelter deck must be fitted on each side of the uppermost complete deck in way of the middle line opening.
- (3) **Middle Line Openings and 3 X 4 Foot Tonnage Openings** When the shelter deck space forward or aft of the middle line opening is divided by interior bulkheads, only those compartments with at least two openings that progress to the middle line opening are considered “open to the weather” under paragraph (e)(1) of this section. Each required opening must be at least three feet wide and at least four feet high in the clear, must not have a coaming height of more than two feet, and must not be fitted (except as provided in paragraphs (d)(4), (d)(5) and (d)(6) of this section) with any means of closing. Other compartments within the shelter deck space are not considered “open to the weather” under paragraph (e)(1) of this section.
- (f) **WATER BALLAST SPACES**  
A space, regardless of location, adapted only for water ballast and not available for stores, supplies, fuel, or cargo (other than water to be used for underwater drilling, mining, and related purposes, including production), upon request, may be exempt from gross tonnage if the following are met.
- (1) **Available Only For Water Ballast** The space must be available at all times only for water ballast that is piped through a system independent of other systems (except fire fighting and bilge suction systems). Pumps, pipes, and other equipment for loading and unloading water ballast must be of a size suitable for the efficient handling of the water ballast within a reasonable time frame.
- Manhole Requirements** All manholes providing access to a water ballast space must be oval or circular and not greater than 34 inches in diameter. Except for those on a deck exposed to the weather, the manholes may have a coaming not exceeding six inches in height.
- Hatch Requirements** Existing hatches over spaces being converted to water ballast spaces must have a water tight cover plate welded to the hatch and a manhole, as described in this paragraph, fitted in the plating.
- (2) **Purpose of Water Ballast** The primary purpose of the water ballast must be to afford a means of maintaining the vessel’s stability, immersion, trim, pre-loading conditions, or seakeeping capabilities.
- (3) **Relation to Stability Analysis** If the space is in a vessel that is subject to inspection under 46 U.S.C. 3301, the space must be considered when determining the adequacy of the vessel’s stability under 46 CFR chapter I.

- (4) **Water Ballast Justifications** If the total of all water ballast spaces to be exempted from gross tonnage exceeds 30% of the vessel's gross tonnage (as calculated under this subpart without any allowance for water ballast), a justification of the operating conditions that require the water ballast must be submitted to the measuring organization for approval. Although a single condition may justify all water ballast spaces, several conditions may be necessary in other cases. However, a particular tank is not justified by a condition if another tank already justified by another condition could be used as effectively. The justification must -
- (i) Designate the vessel's service;
  - (ii) Explain for what purpose under paragraph (f)(2) of this section the water ballast is being used;
  - (iii) Provide the calculations required in paragraphs (f)(4)(vi) through (f)(4)(ix) of this section for those uses on a form similar to Coast Guard Stability Test Form CG-993-9;
  - (iv) Include the capacity, tank arrangement, and piping plans for the vessel;
  - (v) Include a statement certifying that the space will be used exclusively for water ballast as prescribed by this section;
  - (vi) If water ballast is used for stability, describe each loading condition and the resultant metacentric height (GM) and include calculations;
  - (vii) If water ballast is used for immersion or trim, describe those conditions and include loading and trim calculations;
  - (viii) If water ballast is used for preloading, describe how it is used and include strength and weight calculations; and
  - (ix) If water ballast is used for seakeeping, describe each loading condition, GM, period of roll, and, if speed is involved, speed versus trim and draft and include calculations.
- (5) **Reporting of Changes** If the water ballast space or its use, purpose or piping are changed, the vessel owner or operator must report the change promptly to a measurement organization listed in §69.15 for a determination as to whether a tonnage measurement is required. *Changes in vessel service should also be reported if a water ballast justification was required to be submitted for the vessel.*

**(g) METHODS FOR MEASURING EXEMPT SPACES**

- (1) **Superstructure** If the exempt space is located within the superstructure, the exempt space is measured using the same procedures used to measure superstructure tonnage under §69.113.
- (2) **Between-Deck** If the exempt space is located between-deck, the space is measured using the same procedures used for between-deck tonnage under §69.111(c), except that the length of the exempt space is divided into the even number of spaces most equal to the number of spaces into which the between-deck was divided.
- (3) **Under-Deck** If the exempt space is located under-deck, the space is measured using the same procedures used for under-deck tonnage under §69.109, except that the length of the exempt

space is divided into the even number of spaces (*intervals*) most equal to the number of spaces (*intervals*) into which the under-deck was divided. *In all cases, the tank's tonnage length is taken as the longitudinal distance between the extreme ends of the tank, exclusive of any portion of the tank fore/aft of the respective under-deck tonnage length termination points. Use the following procedure to ensure that under-deck water ballast space exemptions reflect only the portions of water ballast spaces that were included in the under-deck volume calculations. In applying this procedure to a tank that consists of a series of contiguous but distinct spaces of varying shapes and sizes, the volume of each distinct space is calculated separately, rather than treating the distinct spaces within the tank as a single tank.*

(i) **Show Tank and Under-Deck Stations** Develop a plan view or side profile, showing the tank stations and the under-deck tonnage stations.

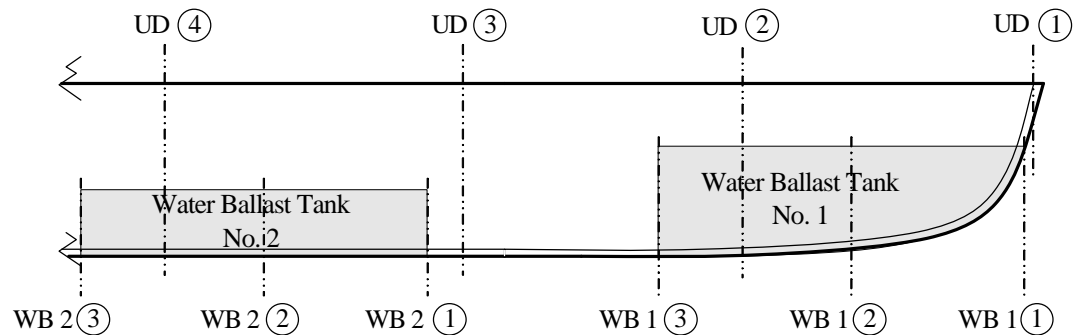

(ii) **Lay Out Zones of Influence** On this plan view or side profile, lay out zones of influence around each under-deck tonnage station. The zones of influence are as follows, depending on the Simpson's first rule multiplier for the associated under-deck tonnage station:

Simpson's Multiplier	Length of Zone of Influence
1	One 1/3 common interval
2	Two 1/3 common intervals
4	Four 1/3 common intervals

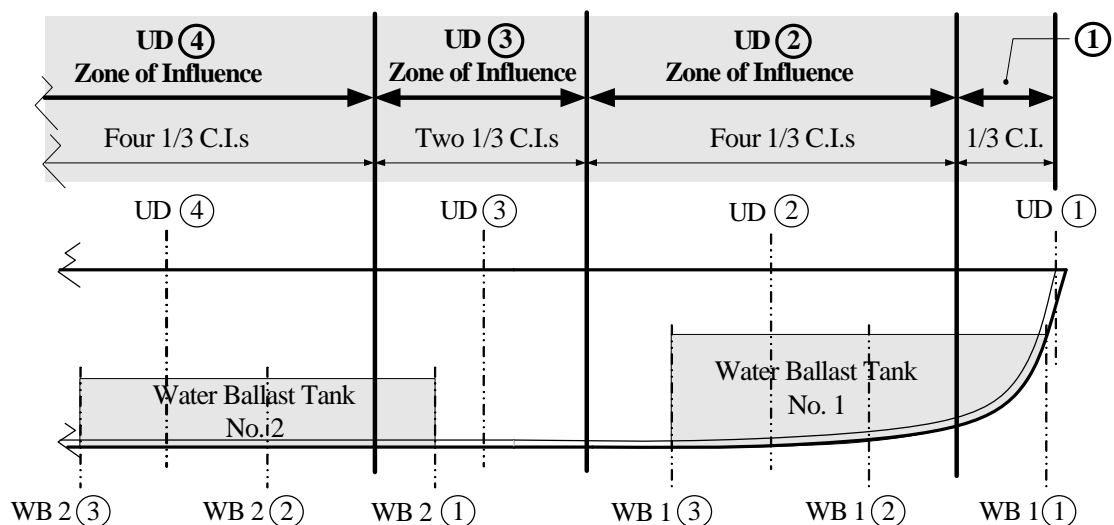

(iii) **Identify Associated Under-Deck Tonnage Stations** For each tank station, identify the under-deck tonnage station under whose “zone of influence” the tanks station falls. In cases where the tank terminates precisely at the boundary between two zones of influence, chose the zone of influence that will yield the largest tank sectional area under step (iv) below.

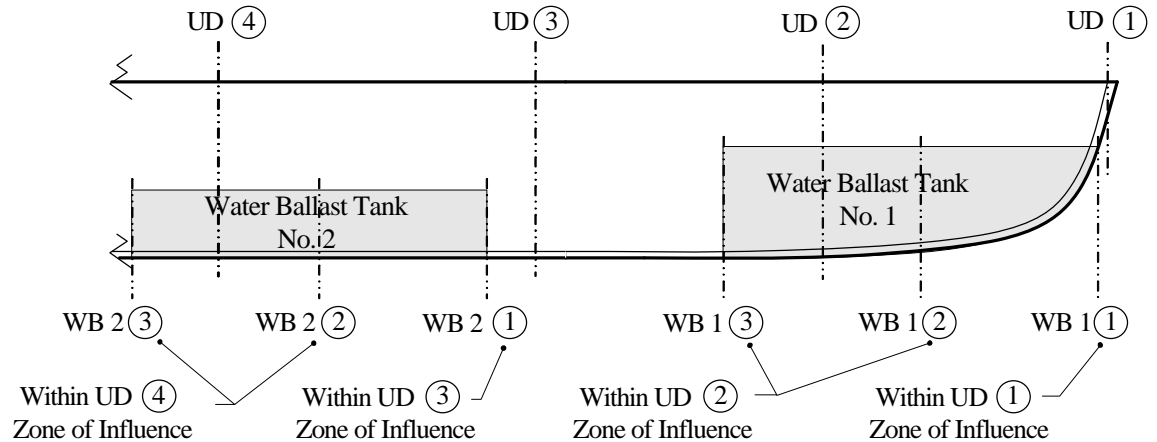

(iv) **Superimpose Tank Sections on Under-Deck Sections** Superimpose (project) the outline of each complete tank section (i.e., to the skin of the tank) onto the associated under-deck tonnage section at the under-deck tonnage station identified in step (iii) above. Then, for each tank station, calculate the tank sectional area by applying Simpson’s first rule to the portion of the tank that is inboard of the line of the ordinary frames of the under-deck section.

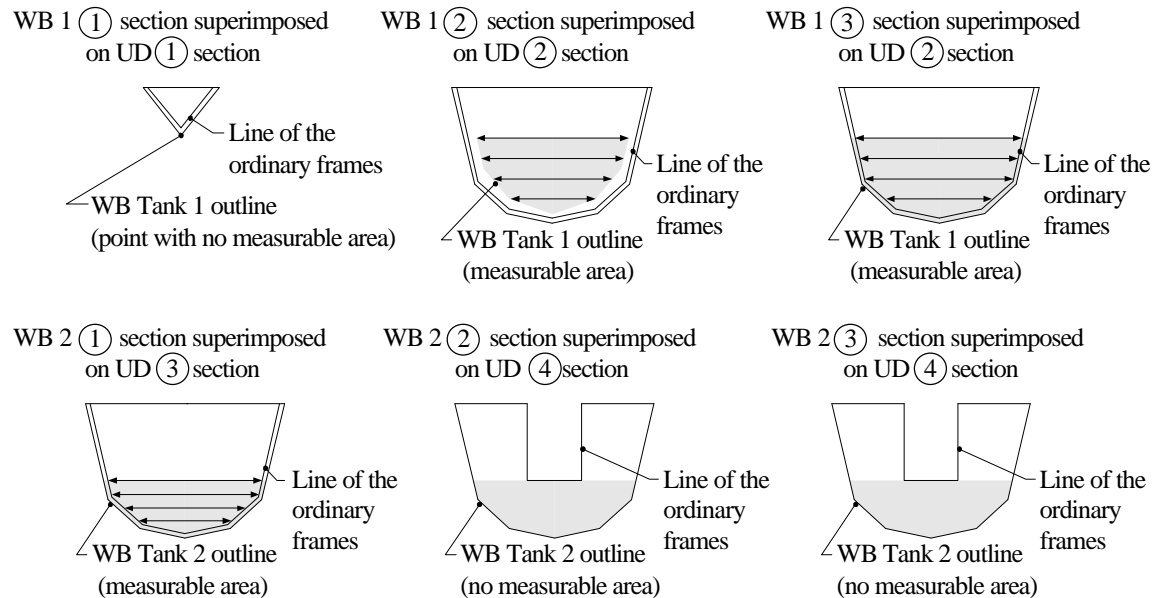

(v) **Perform Longitudinal Integration** Perform a longitudinal integration using the tank’s “tonnage” length, and the sectional areas calculated in step (iv) above. The resulting tank volume is converted to tonnage using the procedures of §69.109.

## 69.119 SPACES DEDUCTED FROM GROSS TONNAGE

### (a) PURPOSE

This section lists the requirements for spaces (other than propelling machinery spaces under §69.121), which, though included in calculating gross tonnage (i.e., are not exempt under §69.117), are deducted from gross tonnage in deriving net tonnage.

### (b) GENERAL

*The following general requirement apply for spaces to be deducted from gross tonnage:*

- (1) **General Restrictions** A deductible space must be used exclusively for, and be reasonable in size for, its intended purpose.
- (2) **Working Space** When a space is larger than necessary for the safe and efficient operation of deductible equipment, only the space occupied by the equipment plus a two foot maximum working space on each side of the equipment, if available, is deductible.
- (3) **Location** Space specified in this section may be located anywhere within the vessel, unless otherwise specified.

**NOTE:** *With the exception of a propelling machinery space, a space otherwise eligible for deduction need not be deducted if the vessel owner requests that it be included in the net tonnage.*

### (c) ANCHOR GEAR

A space below the line of the uppermost complete deck, occupied by the anchor gear, capstan, windlass, and chain locker is deductible. A fore peak used exclusively as a chain locker is measured by the method prescribed under §69.117(g)(3).

### (d) BOATSWAIN'S STORES

A space containing oils, blocks, hawsers, rigging, deck gear, or other boatswain's stores for daily use is deductible. The maximum deduction allowed for vessels less than 100 gross tons is one ton and, for vessels 100 gross tons or over, is one percent of the gross tonnage, not to exceed 100 tons.

### (e) CHART ROOM

A space for keeping charts and nautical instruments and for plotting the vessel's course is deductible. For a combined wheelhouse and chart room, that part not exempted as wheelhouse under §69.117(b)(9) is deductible. For small vessels in which the only space for a chart room is in a cabin or saloon, one half the space not to exceed 1.5 tons is deductible as chart room.

### (f) DONKEY ENGINE AND BOILER

Donkey engine and boiler space is deductible when connected with the main (non-cargo) pumps of the vessel, except as follows:

- (1) **Space within Engine Room or Casing** If the space is within the engine room or within the casing above the engine room and if the donkey engine is an auxiliary to the main propelling machinery, the space is an engine room deduction under §69.121(b).
- (2) **Space above Uppermost Complete Deck** If the space is above the line of the uppermost complete deck and if the donkey engine is not an auxiliary to the main propelling machinery, the space is exempt under §69.117(b)

**(g) SPACES FOR THE EXCLUSIVE USE OF OFFICERS OR CREW**

*This section provides minimum requirements for deductible spaces that are for the exclusive use of officers or crew.*

**(1) *Miscellaneous Officer/Crew Spaces*** The following spaces, regardless of their location (unless otherwise noted), are deductible if not used by passengers:

**(i)** Sleeping rooms

**(ii)** Bathrooms with a bath tub or shower but without a water closet

**(iii)** Water closets below the line of the uppermost complete deck serving more than one person, with or without a bath tub or shower. Water closets, regardless of location, that serve only one person or that are accessible only through a stateroom or bedroom serving one person are considered as part of the space they serve and are deductible only if that space is deductible.

**(iv)** Clothes drying rooms

**(v)** Drinking water filtration or distilling plant below the line of the uppermost complete deck.

**(vi)** Hospitals

**(vii)** Mess rooms

**(viii)** Office of the Chief Engineer

**(ix)** Oil skin lockers

**(x)** Pantries

**(xi)** Recreation rooms

**(xii)** Smoking rooms

**(xiii)** Galleys below the line of the uppermost complete deck.

**(2) *Shops*** Shops for engineers, carpenters, plumbers, or butchers and offices for clerks, pursers, or postmasters are not deductible, wherever located.

**(h) MASTER'S CABIN**

The master's sleeping room, dressing room, bathroom, observation room, reception room, sitting room, water closet, and office are deductible.

**(i) RADIO ROOM**

Spaces in which radio apparatus is installed and messages are sent and received and which may provide off-duty operator accommodations are deductible.

**(j) STEERING GEAR**

Spaces for steering gear below the line of the uppermost complete deck are deductible.

**(k) GENERATORS**

Spaces for generators below the line of the uppermost complete deck are deductible regardless of what space the generators serve. These spaces may include other equipment necessary for the generator's operation.

**(l) PUMP ROOM**

Spaces below the line of the uppermost complete deck containing pumps that are not capable of handling cargo and that are not fuel oil transfer pumps considered part of the propelling machinery under §69.121(b)(2)(v) are deductible.

**(m) SAIL STOWAGE**

A space for stowing sails on a vessel propelled only by sails is deductible up to two and one-half percent of the vessel's gross tonnage.

**(n) WASTE MATERIAL SPACE**

**(1) Storage Spaces** A tank or collection space, regardless of location, used for the carriage or collection of sewage, garbage, galley waste, trash, slop-oil mixture, tank cleaning residue, bilge residue, or other waste material generated aboard the vessel is deductible.

**(2) Processing Spaces** Space below the line of the uppermost complete deck used exclusively to separate, clarify, purify, or otherwise process waste material generated aboard the vessel is deductible.

**(o) PASSAGEWAYS**

A passageway or companionway is deductible -

**(1)** If it serves deductible spaces only; or

**(2)** If it serves deductible spaces and is also the sole means of access to one of the following non-deductible spaces:

**(i)** Lockers of less than two tons each, containing medicine, linen, mops, or other items for the free use of the crew.

**(ii)** A ship's office.

**(iii)** Spare rooms (not exceeding two) used by a pilot, customs officer, reserve engineer, or employee or agent of the vessel's owner or operator.

**(p) MARKINGS FOR DEDUCTIBLE SPACES**

*This section provides minimum requirements for marking of deductible spaces.*

**(1) General** Each space deducted under this section must be marked with the words "Certified \_\_\_\_\_" (inserting the space designation, such as "Seaman", "Generator", "Office of Chief Engineer", "Hospital", or "Anchor Gear"). If a deductible space berths more than one crew member, the marking must indicate the number of crew members berthed, such as "Certified \_\_\_\_\_ Seaman" (inserting the number of crew).

**(2) Abbreviations** The abbreviations "Cert." for "certified" and "W.C." for "water closet" may be used.

- (3) **Lettering** The markings must be in Roman letters and Arabic numerals at least 1/2 inch in height, must be painted in a light color on a dark background, must be embossed, center-punched, carved, or permanently cut in a bulkhead or metal plate, and must be placed in a legible location over a doorway on the inside of the space. A metal plate, if used, must be permanently fastened in place by welding, riveting, lock screws, or a Coast Guard-approved bonding agent.

(q) **METHOD FOR MEASURING DEDUCTIBLE SPACES**

*This section provides general requirements for measuring deductible spaces.*

- (1) **Rectangular Spaces** A rectangular space must be measured by taking the product of its length, breadth, and height.
- (2) **Spaces with Curved Sides Above Tonnage Deck** A space with curved sides on or above the tonnage deck is measured according to §69.109.
- (3) **Spaces Less Than 15 Feet Long** Space less than 15 feet in length may be measured by any practical method.
- (4) **Spaces with Curved Sides Below Tonnage Deck** Spaces below the tonnage deck exceeding 15 feet in length and bounded by a curved surface conforming to the side of the vessel must be measured by the formula used for measuring the superstructure under §69.113.
- (5) **Spaces on Platforms** The height of a space located on a platform in the hull must be measured from the top of the bottom hull frames, if the platform is used only to form a flat surface at the bottom of the space, if the platform is not more than one foot above the top of the bottom frames, and if the space below the platform is not usable.
- (6) **Treatment of Ceiling** The height of a space is measured through any ceiling, paneling, false overhead, or other covering, to the space's structural boundary, unless the space enclosed by the covering is available for a non-deductible use.

**69.121 ENGINE ROOM DEDUCTION**

(a) **GENERAL**

The engine room deduction is either a percentage of the vessel's total propelling machinery spaces or a percentage of the vessel's gross tonnage.

(b) **PROPELLING MACHINERY SPACES**

- (1) **General** Propelling machinery spaces are the spaces occupied by the main propelling machinery and auxiliary machinery and spaces reasonably necessary for the operation and maintenance of the machinery. Propelling machinery spaces do not include spaces for fuel tanks, spaces exempt from gross tonnage under §69.117, and spaces not used or not available for use in connection with propelling machinery.
- (2) **Specific Spaces** Propelling machinery spaces are -
- (i) Space below the crown. The crown is the top of the main space of the engine room to which the heights of the main space are taken. The crown is either the underside of a deck or, if the



side bulkheads are sloping, the uppermost point at which the slope terminates. (See 69.123, figures 13 and 14).

- (ii) Framed-in space located between the crown and the uppermost complete deck and used for propelling machinery or for the admission of light or air to propelling machinery spaces. (See §69.123, figures 13 and 14).
- (iii) Shaft tunnel space and thrust block recess space.
- (iv) Space below the uppermost complete deck used for escape shafts or trunked ladderways leading from the aft end of the shaft tunnel to the deck above.
- (v) Space containing a fuel oil transfer pump located in a separate space and not used for bunkering the vessel. When the pump serves both ballast and fuel oil, only one-half of the pump's space is considered a propelling machinery space.
- (vi) Spaces containing fuel oil settling tanks used solely for the main boilers. The space must not exceed one percent of the vessel's gross tonnage.
- (vii) Spaces for engineers' stores and workshops located below the uppermost complete deck and either open to a propelling machinery space or separated from a propelling machinery space only by a screen bulkhead. The space must not exceed three-quarters of one percent of the vessel's gross tonnage.
- (viii) Framed-in space located above the line of the uppermost complete deck and used for propelling machinery or for the admission of light or air to a propelling machinery space, when requested under paragraph (d) of this section.
- (ix) If the propelling machinery is boxed-in below the tonnage deck, the boxed-in spaces plus the spaces outside of the boxing for the shaft, auxiliary engines, and related propelling machinery. If a portion of the boxed-in space extends above a platform or partial deck that is below the uppermost complete deck, that portion is also considered part of the propelling machinery space.

**(c) METHODS FOR MEASURING PROPELLING MACHINERY SPACES**

*This section provides requirements for measuring propelling machinery spaces.*

- (1) If the propelling machinery space is bulkheaded off or is not larger than necessary for the safe operation and maintenance of the propelling machinery, the entire space, or, if bulkheaded off, the portion bulkheaded off, is measured for the engine room deduction.
- (2) If the propelling machinery space is not bulkheaded off or is larger than necessary for the safe operation and maintenance of the propelling machinery, only the space occupied by the propelling machinery itself plus a working space of two feet, if available, on each side of the propelling machinery is measured for the engine room deduction. If the working space overlaps another working space not related to the propelling machinery, only one-half of the overlapping working spaces is included in the propelling machinery space. The height of the working space is measured as provided in paragraph (c) of this section.
- (3) If the propelling machinery is located in more than one space, each space must be measured separately.

- (4) If the propelling machinery is located in a space with a step in the bottom or side lines, each stepped portion of the space must be measured separately.
  - (5) The length of a space under paragraph (c)(1) of this section is measured from the bulkhead just forward of the propelling machinery to the bulkhead just aft of the propelling machinery. The length of a space under paragraph (c)(2) of this section is measured from the forward edge of the working space to the aft edge of the working space.
  - (6) If the boundaries of the propelling machinery space form a rectangle, the product of the length, breadth, and height, divided by 100, is the tonnage of the space.
  - (7) If the boundaries of the propelling machinery space are continuous fair lines, heights are measured at the fore and aft ends and at the center of the space from the bottom frames, floors, or tank top of a double bottom (*water ballast*) up to the line of the crown. A breadth is measured at half-height of each height. The product of the length, mean breadth, and mean height, divided by 100, is the tonnage of the space.
  - (8) If the propelling machinery space is in the aft end of the hull, extends from side to side of the hull, and has a continuous bottom line, the length of the space is divided into the even number of equal parts most nearly equal to the number of parts that the tonnage length under §69.109(g) was divided. The tonnage is then calculated by the same method used for calculating the under-deck tonnage in §69.109(l).
  - (9) The tonnage of a framed-in space located between the crown and the uppermost complete deck and used for propelling machinery or for the admission of light or air to the propelling machinery space, is the product of its length, breadth, and height, divided by 100.
  - (10) The tonnage of a shaft tunnel, or a thrust block recess, having a flat top is the product of its length, breadth, and height, divided by 100. If the shaft tunnel or thrust block recess top is not flat, the space above must be calculated by using the appropriate geometrical formula. If the space aft of the shaft tunnel extends from side to side of the vessel, the tonnage of the space is found by the formula for measuring peak tanks in §69.109(l).
  - (11) The length and breadth of the space for the shaft tunnel, or a thrust block recess, when not cased is that which is necessary for maintenance of the shaft. The height allowed for thrust block recess space must not exceed seven feet. The mean height allowed for the shaft tunnel space must not exceed six feet. In a multi-screw vessel where the shaft tunnel or thrust block recess space is open from side to side, measure only the space used for purposes of propelling the vessel.
  - (12) When the propelling machinery is on a bed at the vessel's bottom, the height of the propelling machinery space is measured from the top of the bottom frames or floors.
- (d) **ENGINE ROOM SPACES ABOVE LINE OF THE UPPERMOST COMPLETE DECK**  
*Spaces meeting the specific requirements below may also be deducted as propelling machinery space. Requests to treat certain framed-in engine room spaces as part of a propelling machinery space must be submitted in accordance with paragraph (1) below.*
- (1) Under §69.117(b)(4), framed-in spaces located above the line of the uppermost complete deck and used for propelling machinery or for admitting light or air to a propelling machinery space are exempt from inclusion in tonnage. However, upon written request to a measurement organization

listed in §69.15, the vessel owner may elect to have these spaces included in calculating gross tonnage, then deducted from gross tonnage as propelling machinery spaces under paragraph (b)(2)(viii) of this section.

- (2) The framed-in space must be safe, seaworthy, and used only for propelling machinery or for the admission of light or air to the propelling machinery space. The length of the space must not exceed the length of the propelling machinery space and the breadth must not exceed one-half of the extreme inside midship breadth of the vessel. Portions of the framed-in space that are plated over are not included in the propelling machinery space.
- (3) To exercise the option in paragraph (d)(1) of this section, all of the framed in space need not be treated as propelling machinery space, but only that portion required to entitle the vessel to have 32 percent of its gross tonnage deducted as an engine room deduction under paragraph (e) of this section.

**(e) CALCULATING THE ENGINE ROOM DEDUCTION**

- (1) **General** The engine room deduction is based on a percentage of the vessel's gross tonnage or a percentage of the total propelling machinery space.
- (2) **Vessels Propelled by Screw** For vessels propelled in whole or in part by screw -
  - (i) If the total propelling machinery space is 13 percent or less of the vessel's gross tonnage, deduct 32/13 times the total propelling machinery space;
  - (ii) If the total propelling machinery space is more than 13 but less than 20 percent of the vessel's gross tonnage, deduct 32 percent of the vessel's gross tonnage; or
  - (iii) If the total propelling machinery space is 20 percent or more of the vessel's gross tonnage, deduct either 32 percent of the vessel's gross tonnage or 1.75 times the total propelling machinery space, whichever the vessel's owner elects.
- (3) **Vessels Propelled by Paddle Wheel** For vessels propelled in whole or in part by paddle-wheel -
  - (i) If the total propelling machinery space is 20 percent or less of the vessel's gross tonnage, deduct 37/20 times the total propelling machinery space;
  - (ii) If the total propelling machinery space is more than 20 but less than 30 percent of the vessel's gross tonnage, deduct 37 percent of the vessel's gross tonnage; or
  - (iii) If the total propelling machinery space is 30 percent or more of the vessel's gross tonnage, deduct either 37 percent of the vessel's gross tonnage or 1.5 times the total propelling machinery space, whichever the vessel's owner elects.